

California Gymkhana Association

PO Box 410, Wilton, CA 95693

Phone: (916) 698-1866

Email: CGAState@gmail.com

Website: www.CalGymkhana.com

CGA RULE BOOK

LAST REVISION DATE:

11/16/2024

Published by the California Gymkhana Association. All rights reserved. Reproduction without permission is strictly prohibited.

Copyright ©1973 by the California Gymkhana Association. Revised 1985, 1990, 1991, 1992, 1994, 1996, 1997, 1998, 1999, 2003, 2005, 2006, 2007, 2008, 2009, 2010, 2011, 2012, 2014, 2015, 2016, 2023, 2024

Forward

The California Gymkhana Association was founded in 1972 by gymkhana people, for gymkhana people. It was founded to serve all horsemen who want to participate in gymkhana riding, to offer all riders the opportunity to compete under a uniform set of rules that are suited to their abilities, and to bring to many more young people the enjoyment of horsemanship and sportsmanship that gymkhana can provide.

It is the duty of every California Gymkhana Association (CGA) member to read and be well acquainted with the information contained in the following pages, as the rules stated herein are the sole basis by which shows are judged.

Every precaution has been taken to ensure the rules contained herein have been printed with the true meaning and intent as stated. However, in the event of printing error or misconstrued meaning, the true intent of the rule shall prevail and at all times the interpretation of the Rules Committee shall be final.

Table of Contents

Forward	2
Introduction	6
Section 1: Horse Show Management Ground Rules	7
Section 2: Divisions of Competition	7
2.1 General.....	7
2.2 Two or More Classes in the Same Event	7
2.3 Special “Lead Line” Rules for Riders who need assistance	8
2.4 Riding Below Where You Are Rated	8
Section 3: Entry Requirements	9
3.1 Clothing and Tack.....	9
3.2 Unsoundness or Injury	10
3.3 Cross Entries.....	10
3.4 Stallions.....	10
3.5 Pony Size and Certification Process	11
Protesting a Pony Measurement.	11
Section 4: General Procedures	12
4.1 General.....	12
4.2 Be Prepared to Run.....	13
4.3 Enter the Arena and Begin Course.....	13
4.4 Falling Off Horse Prior to Beginning Course	13
4.5 Run the Course.....	13
4.6 Finish the Course.....	14
4.7 Leave the Arena.....	14
4.8 Judge’s Decision.....	14
Section 5: Penalties	15
5.1 General Conduct of Contestants.....	15
5.2 Proper Dress and Equipment	15
5.3 Cruel or Inhumane Treatment of Horses	16
5.4 Entering the Arena.....	16
5.5 Loss of Control	17
5.6 Loss of Forward Motion	17
5.7 Knocking Down or Touching Obstacles	17
5.8 Failure to Complete a Course.....	18

5.9 Failure to Leave Arena When Notified	18
5.10 Breaking or Knocking Down Barrier of Divided Arena.....	18
5.11 Use of Illegal Drugs or Alcoholic Beverages	18
Section 6: Gymkhana Judges	19
6.1 Requirements to Become a CGA Judge.....	19
6.2 Inactive Judges	20
Section 7: Equipment, Material and Timer Specifications	21
7.1 Timing.....	21
7.2 Open Reel Tap Measure	22
7.3 Poles.....	22
7.4 Barrels	23
7.5 Rakes	23
7.6 Lime	23
7.7 Pails, Sand and Flags.....	23
7.8 Jumps	23
7.9 Ribbons	24
7.10 Speedball Race	24
7.11 Keyhole	24
Section 8: Gymkhana Events Course Layouts and Patterns	25
8.1 General Information.....	25
8.2 Events for Individual Contestants.....	26
8.3 Course Layout Diagram.....	26
8.4 Course Pattern Diagrams.....	40
8.5 Team Events	53
Section 9: Protests	61
Appendix A: Construction of Cone for Speed Ball	62
Appendix B: Construction of Poles for Pole Bending	63
Appendix C: Construction of Hurry Scurry Jumps	64
Appendix D: Pony Measurements	65
Bolado Park State Show Records	66
Horses.....	66
Ponies	66
Bolado Park State Show Records: Team Events.....	67
All Time State Show Records.....	68
Horse.....	68

Ponies 68
All Time State Show Records: Team Events 69
Notes for Rules 70

Introduction

The rules of the California Gymkhana Association allow management the flexibility in the design of the gymkhana shows (i.e., Section 2) and at the same time:

Ensure equal opportunity for the contestants, maximize the safety of the horse* and rider, establish a reasonable code of dress and conduct, and ensure humane treatment of horses.

In addition, Section 4 is provided, that summarizes general procedures recommended to be followed at horse shows. Every effort has been made to organize the contents of this rule book for ready reference and understanding by both horse show contestants and management. Steps to be followed by horse show management in planning a show include the following:

- A. Select the desired gymkhana events from those described in Section 8.
- B. Determine the equipment, materials and timing specifications for these events by referring to Section 7. Make certain that these items will be available for use at the proposed show.
- C. Determine the groups and division of competition for your show (refer to Section 2).
- D. If your show is to be recognized by the CGA, you must use a carded CGA Judge (refer to Section 6).
- E. Refer to Section 3 for entry requirements.

*Note: The use of the term “Horse” throughout this book shall include all equine partners, including horses, ponies, donkeys and mules.

Section 1: Horse Show Management Ground Rules

Ground Rules may be used to state requirements in addition to those specified by the California Gymkhana Association. However, they shall not be in conflict with the rules of the CGA.

Section 2: Divisions of Competition

2.1 General

Show Management may offer separate competitions for horses and ponies. Any competition may be further divided if desired. For example, competition may be divided by age and/or sex of rider, height of pony, and/or divisional competition according to speed, providing the premium list states so. **With the exception of Lead Line riders and the Hurry Scurry event, all events are open to all riders who wish to participate. No rider should be allowed to ride below where they are rated if riding for awards.**

2.2 Two or More Classes in the Same Event

Two or more classes in the same event may be combined if there is an insufficient number of entries in either class. If classes are combined, any rider affected may withdraw their entry and is entitled to a full refund of entry fee for that class from which the horse is withdrawn.

2.3 Special “Lead Line” Rules for Riders who need assistance

The CGA is interested in providing an opportunity for riders who need assistance to participate in CGA Shows. For this reason, the following special rules shall be applied at CGA Shows that allow participation of these riders:

- A. A rider may be led through the course by a parent or responsible party and an additional assistant (if needed), provided the rider is not able to complete the course without assistance. Such assistance is allowed to ensure the safety of the rider but does not extend to the assistant(s) touching the poles, flags or other obstacles. The Lead Line Team (Horse, rider, leader and additional assistant) must properly complete the course. The assistant(s) must conform to the same dress code defined for judges (See Section 6.1).
- B. Hard hats are mandatory for all Lead Liners riders. The animal being led shall be in normal tack with the addition of a halter and lead rope.
- C. Lead Line riders may NOT participate in the Hurry Scurry event for safety reasons.
- D. A mount may NOT be entered in the same event more than once except as a Lead Line Entry.
- E. Lead Line riders may proceed no faster than a trot or they will be disqualified.
- F. When Leading the animal across the timing line, the assistant must be at or behind the shoulder of the animal to prevent any timer malfunctions.

2.4 Riding Below Where You Are Rated

A rider may not ride below their current rating at any district show, when riding for district awards.

Section 3: Entry Requirements

3.1 Clothing and Tack

The high standards of gymkhana will be reflected by the rider's full and proper dress as follows:

1. **CLOTHING:** A safety helmet (hard hat) is required when riding any CGA event, unless the adult rider (18 or over) signs a waiver that indicates refusal to wear a safety helmet. An approved safety helmet is required for all riders under the age of 18. The helmet must be correctly worn at all times while mounted on the show grounds. Nothing that effects the proper fit may be worn under the helmet. If a rider under 18 enters the arena without a helmet correctly worn, they will be disqualified from the event. If a rider under 18 has more than one helmet violation on the same day, they will be disqualified from the show.

Clothing shall be neat and clean. All contestants shall be fully attired in a dress shirt with a button or snap (function or non-functional) in the front from top to bottom and a collar. Long Pants, belt or ½ belt and boots. The shirt may have a front or back zipper. If the shirt has a front zipper, it must be covered by non-functional button or snaps from top to bottom. Shirts must be tucked into pants. Only the top 2 buttons of the shirt may be left unbuttoned as long as the buttons go to the collar line of the shirt. A tie or neckerchief is not required but is encouraged.

A boot is defined as either a traditional western, traditional English or roper style boot that laces up that is minimum of 1 ½" above the ankle. All other boots must be approved by the CGA Rules Committee. All boots must have at least a ½" heel and a smooth sole. Patterned soles are permitted if the patten is 1/8" or less deep. "Waffle" soles are specifically prohibited.

All articles of clothing shall be properly worn. However, buckles may be worn at the side or back for comfort reasons. Chaps may be worn. A western hat may also be worn but a means must be devised to keep it on while running the course.

2. **TACK:** Any appropriate, neat and humane western and/or English equipment may be used with the following exception: the judge may prohibit

the use of bits or equipment he or she may consider severe or unsafe. Riders are permitted to use whips, crops, quirts and spurs if used sparingly, so long as these aids do not result in abuse of the horse. A rider may use any part of the horse or saddle to maintain balance. Use of a tie down is permitted.

3.2 Unsoundness or Injury

Management shall not allow any horse to participate when unsoundness or injury is sufficient to be considered an act of cruelty. The existence of a veterinarian's note does not automatically grant an exemption. The final decision belongs to CGA and the judge may decide that using the animal would be an act of cruelty. Any ambiguous situation should be referred to a CGA Master Judge and/or the CGA Rules Committee.

3.3 Cross Entries

A horse cannot be entered more than once in any event, with the exception of Lead Line (see Section 2.2).

The same rider/horse combination may NOT be entered more than once in the same event in the same arena at the same district show on the same day. This includes Lead Line riders.

3.4 Stallions

No one under 18 years of age will be permitted to ride a stallion at a CGA sanctioned show.

3.5 Pony Size and Certification Process

To qualify an animal to compete in a CGA Pony Division at a State Sponsored Show or for CGA State Year End Awards the animal must measure 13.2 hands or fifty-four (54") inches or less without shoes. An additional one-quarter (1/4") inch is allowed when a pony is shod. The measurement is taken using a CGA provided rigid measuring stick that has a leveler built into the horizontal arm. Ponies that are fifty-two (52") inches or less may be measured by a Master Judge and a Senior Judge. Ponies that are over fifty-two (52") inches must be measured by two (2) Master Judges.

Certification expires at the conclusion of the current season. All annual certificates must be submitted to the CGA State Office by the certifying Master Judge(s). A copy should be given to the member for their records. Certificates are supplied to the Master Judges by CGA State Office.

You may ask for a measurement for informational purposes (not a pony certificate) one time per season to verify if you need trimming, shoes or a calmer time for your pony. You ask for the Information and Certificate measurement at the same measuring session, so long as the pony does not leave the measuring area or the visual range of the Master Judge(s) doing the measuring.

The final decision to certify an animal as a CGA Pony lies with the Master Judges(s) measuring the animal. The Master Judges Advisory Committee reserves the right to require a pony to be remeasured if a majority feels that circumstances have changed since the certification was granted.

For pony measuring procedures see Appendix D.

Protesting a Pony Measurement.

If you fail a pony measuring session, you may file a formal protest and have one (1) remeasuring session. The formal protest must be sent in writing to the CGA State Office with a \$100 fee within 30 days of the failed session. This \$100 fee will be refunded if the pony passes at the remeasure. It is the protesters' responsibility to contact and arrange a new pony measuring session with their district Master Judge or the Master Judges Advisory Committee after the protest is filed. If the pony fails the remeasure, then the pony will not be allowed to be

measured again until the following show season and will run the current season as a horse.

Note: The motion would include that if this passes that it starts immediately. All those ponies who received certificates at State Show 2023, be allowed to run through the completion of State Show 2024. Then all pony certificates will run with the CGA show season.

Section 4: General Procedures

4.1 General

Much can be done by riders and horse show management to make a show run more smoothly and help gymkhana contestants improve their horsemanship practices. The following procedures are set forth to acquaint horse show management and new riders with the normal progression of a well-run show. **It is mandatory that a carded judge be present in the arena to oversee course setup.** Some of these procedures are only suggestions. Others incur penalties as set forth in the penalty section of this book. Judges are cautioned that no penalty should be imposed for violations of procedures unless they are enumerated in the penalty section (Section 5).

- A. Position of poles and obstacles:** After measuring each course, place a spot of lime under each pole or obstacle so that it may be put back in the same position in the event it is knocked down. Each obstacle shall be centered over the spot of lime. In the event the lime spot is obliterated, the course shall be remeasured. All measurements must be made with the tape laying flat on the ground.
- B. Announcers:** Time should be allowed for each rider to warm up their horse. This can be accomplished by giving a warning prior to the start of an event and by reading the names of the next three contestants. The announcer should not interfere with the rider's ride by talking when the rider is in the arena or announce good ride or disqualification without a signal from the judge.
- C. Resetting the course and raking:** After each run, course obstacles should be reset to their original position so that the course will be as identical as possible for each contestant. The course should be raked around each obstacle if required for the safety of the contestants. A contestant has the right to request resetting and/or raking of the course. **Any course may be off by a total of six (6) inches from its' prescribed dimensions and still be considered a legal course when re-checked.**

- D. Gates to the arena:** All gates to the arena should be closed during the running of every event; no gate(s) should be opened until the riders has completed the course, the horse has been brought under control, and the judge has signaled the rider to leave the arena.
- E. Condition of the arena:** The arena should be properly prepared for the gymkhana competition. It should be disked, rocks removed, leveled and watered as required for the safety of the horse and rider.
- F. Re-Rides:** The only time a rider will be required to re-run an event is if the timers malfunction or a course is improperly set. If a rider has successfully completed a legal course and then it is determined there was a problem (for instance the ground is/was unsafe or there was some sort of interference) the affected riders will be given the option for a re-ride

4.2 Be Prepared to Run

All riders should be fully prepared to run when called, be in the proper dress, have equipment in good shape and horses warmed up ready to compete.

4.3 Enter the Arena and Begin Course

The rider will be notified when the course is ready and must enter the arena within one minute after such notification. A rider who remains mounted may be assisted through the gate. After entering the arena, the riders must show control of the horse before the judge will signal approval for the run. The signal should be prompt and loud enough for the rider to hear. This will enable the rider to give undivided attention to the horse while setting it up to run. The course must be started within one minute after notification by the judge. By starting the course, the rider accepts the course as long as the course is legal.

4.4 Falling Off Horse Prior to Beginning Course

If a rider falls off their horse prior to running an event, the judge must excuse the contestant and place him or her at the end of the division or class to complete the event.

4.5 Run the Course

The course must be run in accordance with the prescribed pattern (See Section 5 and 8). A horse is on course when any part of the horse crosses the start/finish line. It remains on course as long as it is run in accordance with the prescribed pattern for the event being run until every part of the horse crosses the start/finish line. If a rider goes off course, but corrects the course, and completes the prescribed pattern, there will be no disqualification or penalty.

4.6 Finish the Course

After the course is completed, the horse must be brought under control before leaving the arena. The rider may circle to bring the horse under control.

4.7 Leave the Arena

The rider is requested to acknowledge the judge after bringing his/her horse under control. The rider should not dismount at any time while in the arena without permission of the judge. However, if the rider dismounts for reason of safety or reasons beyond their control, the judge's permission to dismount is implied.

The above noted procedures are normally considered a matter of courtesy towards horse show management and the judge, and normally there are no penalties associated with them. They may, however, be indicative of unsportsmanlike conduct or a safety issue as referred to in the penalty section, and as such could incur penalties as set forth in that section (Section 5).

4.8 Judge's Decision

All decisions of the head judge in the arena are final. The head judge shall not signal his/her decision until other judges in the arena are monitored to determine their individual rulings. In all cases where a value judgement is required by a judge, the judge shall rule in favor of the contestant when there is any doubt as to the circumstances.

Section 5: Penalties

5.1 General Conduct of Contestants

- A. The use of offensive language, or any other conduct considered by the judge to be detrimental to gymkhana, will not be allowed in the arena. A contestant not adhering to the first warning will be disqualified from an event on the next occurrence. Conduct which jeopardizes the safety of the contestant shall result in disqualification from the horse show. All contestants must display good sportsmanship at all times.
- B. Unsportsmanlike conduct by contestants, parents or relatives of the contestant, inside or outside of the arena, may result in disqualification of the contestant and possible dismissal from the show grounds. Such conduct includes, but is not limited to:
 - 1) Willfully causing trouble by constant complaining, aggravating CGA judges, horse show management, secretaries or other personnel.
 - 2) Accusing or making derogatory statements relative to the performance of judges, secretaries or show officials.
 - 3) Use of a stopwatch or other timing device by the rider or by someone helping the rider to deliberately alter the outcome of a ride.
 - 4) Display Scoreboards – may not have the running time displayed
- C. Unsafe conduct inside or outside the arena.
 - 1) For the safety of the rider, other persons or horses that may be in jeopardy, such actions may result in disqualification.

5.2 Proper Dress and Equipment

- A. A one-second penalty will be added to the time of any rider who starts the course with attire and/or equipment in violation of the rules (refer to Section 3.1). An exception may be given to new riders attending their first show providing prior approval has been obtained from the horse show management and judge. The new rider exception does not apply to State Show. In addition, a rider may be given an exemption for medical reasons providing safety is not compromised. The existence of a Doctor's note does not automatically grant an exemption. The final decision belongs to CGA. The judge may decide that the situation would be unsafe. Any ambiguous situations should be referred to a CGA Master Judge and/or the CGA Rules Committee.

- B. The dress code is in effect and must be adhered to during the running of any CGA events, whether those events are regular events, setups or schooling rides. A rider's obvious disregard for this dress code will preclude that rider's participation in the event.

5.3 Cruel or Inhumane Treatment of Horses

Spurring, striking or beating in any manner whatsoever forward of the cinch after entering the arena will result in immediate disqualification of the contestant. The contest will likewise be disqualified if there is any indication of cruelty such as welts, cuts, bleeding or marks on the animal. Any subsequent violation may result in disqualification of the contestant from the show. Contestants shall be warned for the following

- A. Excessive spurring or jerking of the reins.
- B. Unusual construction or arrangements of equipment considered by the judge to be inhumane or unsafe.
- C. Excessive use of bats or whips.
- D. Cruelty of any kind to the horse while on the show grounds whether or not specifically mentioned.

Any subsequent violation may result in disqualification of the contestant from the show.

5.4 Entering the Arena

- A. A rider may be assisted through the gate and up to the timing line. The assistant cannot pass the timing line inside or outside of the timing poles. Such action will result in a disqualification.
- B. A rider must ride their horse into the arena.
- C. A rider may not school his/her horse prior to running the course. Schooling is defined as going around an obstacle more than once in a close, tight turn. Such action will result in disqualification.

5.5 Loss of Control

Any one of the following will be considered loss of control and will result in disqualification.

- A. Failure to Show Control of Horse:** The horse must be brought under control before beginning the course to show that the rider has complete control. The judge will signal approval for the run only if the rider shows control of the horse. The rider must wait for the judge's approval prior to beginning the run.
- B. Failure to Begin Course:** After entering the arena, the rider must begin the course within one minute after the judge gives the ready signal.
- C. Unruly Horse:** The horse must not be unruly such that, in the opinion of the judge, the safety of the rider might be in jeopardy.
- D. Falling Off Horse While on Course.**
- E. Failure to Enter Arena:** The horse and rider must enter the arena within one minute after being so notified by the judge.
- F. Beginning the Run From Outside the 80' Foul Line.**

5.6 Loss of Forward Motion

The only penalty associated with the loss of forward motion will be in the increased time covering the gymkhana course. Contestants will not be penalized for loss of forward motion.

5.7 Knocking Down or Touching Obstacles

Knocking down or dislodging any obstacle, including timing poles, shall result in a two second penalty for each obstacle (pole, barrel, etc.) knocked down or dislodged. However, touching an obstacle with the intent of keeping it from going down shall not result in a penalty. An obstacle that has been knocked down to the ground and bounces back up to an upright position will be considered a downed obstacle. **In Hurry Scurry, a pole must touch the ground to be considered dislodged.**

5.8 Failure to Complete a Course

A contestant shall be disqualified if, in the opinion of the judge, the course is not completed within the reasonable period of time. This includes problems resulting from the loss or breakage of equipment or tack while negotiating the course wherein the difficulty prevents completion of the course.

5.9 Failure to Leave Arena When Notified

Deliberate failure of a contestant to leave the arena immediately upon notification by the judge shall bar the contestant from further participation in the show.

5.10 Breaking or Knocking Down Barrier of Divided Arena

Breaking or knocking down any part of a barrier or the disruption of timing equipment will result in immediate disqualification. This is true even if it occurs before the rider has started the course or after the rider has completed the course.

5.11 Use of Illegal Drugs or Alcoholic Beverages

No persons are allowed to bring onto the grounds of any CGA function or use or have in their possession any illegal drugs. No persons are allowed to consume or be under the influence of any alcoholic beverages while they are participating in an event.

Section 6: Gymkhana Judges

6.1 Requirements to Become a CGA Judge

Approved CGA shows must be judged by licensed CGA gymkhana judges. The judge must be physically in the arena during each and every rider's run. Apprentice judges must have a licensed judge in the arena with them at all times they are judging an event. Any CGA member may apply to become an apprentice judge at 16 years of age or an official CGA judge at 18 years of age. ***They must complete the entire process within 18 months of getting their apprentice card. If they fail to do so, the apprenticeship is cancelled and the candidate must start over from the beginning. An apprentice may not start judging or taking tests until the apprentice card is received from the CGA State Office.***

Prospective CGA Judges:

- A. Must be a member in good standing.
- B. Must have a broad range of knowledge pertaining to the California Gymkhana Association.
- C. Must judge enough shows as an apprentice judge to become proficient ***within 18 months of getting their apprentice card.***
- D. Must pass an arena test given by a Master Judge ***within 18 months of getting their apprentice card***, demonstrating proficiency in setting up all CGA events.
- E. Must pass a written test given by a Master Judge ***within 18 months of getting their apprentice card.*** The judges test includes questions on many aspects of the CGA other than gymkhana rules given in the CGA Rule Book. A CGA judge is expected to be familiar with the CGA Bylaws and the CGA Information & Regulations Manual that includes information on the CGA Awards Program, Show Procedures and other information about CGA.

(Continued on next page)

- F. A judge's attire shall be in conformance with the dress code given in section 3.1.A with the following exceptions:
- 1) Helmets are not required.
 - 2) The requirement to wear boots is waived and the judge may wear comfortable closed toe shoes.
 - 3) A judge may wear a visor or any appropriate headgear to protect themselves from the sun.
- G. CGA judges are volunteers and may not accept payment for their services. However, many districts provide lunch or provide other non-monetary benefits to their judges in recognition of the work they do.

Questions pertaining to the licensing of CGA judges should be directed to the CGA State Office.

6.2 Inactive Judges

A CGA Judge may request with the State Office or their Master Judge to be on inactive status for up to one (1) year. If a judge is on inactive status for more than one (1) year, they must judge with a carded judge until they are up to speed and then must seek reinstatement to active status by their Master Judge.

If any judge's membership expires (whether active or inactive) for more than one (1) year, the judge is eliminated from the database and must start the process over if they wish to re-establish their card.

Section 7: Equipment, Material and Timer Specifications

7.1 Timing

A. Electronic Timer: Note: The two-timer requirement listed below does NOT apply if a FarmTek MD-300 or more recent FarmTek timer is used. In that case, a single timer is acceptable, but you must still have two people writing times. If you are using the "Direct Timer Input" option with the Polaris timer where the time goes directly into the computer, only one set of handwritten times is required. There must still be two persons in the booth, one operating the computer, the other writing times.

Otherwise, a main time and a backup time shall always be obtained and the rider shall be required to re-run the event if the two times differ by 2/10ths of a second or more. However, the 2/10ths of a second rule does not apply to rides where the total time for the rides is 50 seconds or more. An electronic timer calibrated to a thousandth of a second is **required** as the main time. When two (2) electronic timers are used, the fastest time of the two electronic timers shall be used as the main time.

B. Rider's Option: If a re-run is required because of timer problems, the rider will re-run under **one or the other** of the following conditions:

- 1) One or more obstacles were knocked down during the first run. These penalties will be carried to the second run. However, the penalties attained in the second run will be used for the event if the penalties earned in the second run are equal to or greater than the penalties earned in the first run.
- 2) An Obstacle was **not** knocked down in the first run (clean ride). If an obstacle is knocked down during the second run or a special penalty is assessed (per section 8.4) , the rider will be given the option of a third run and the penalties of the second run are **not** carried over to the third run. The time, including penalties, of the third run will then be used as the final time.

C. Rider's Time: Time shall start when any part of the horse crosses the starting line and shall end when any part of the horse crosses the finish line.

D. Ties: Any ties will be broken by determining which rider has won the most first places by the computer. If the tie still exists the rider with the most second places is selected. This process is to continue, if necessary, to the place required to break the tie. If a tie cannot be broken by the computer, then the district will resolve the tie.

7.2 Open Reel Tap Measure

An open reel tape or an approved equivalent must be used. It is recommended the tap be at least 150 feet in length. A 300' tape is best.

7.3 Poles

Poles shall be constructed per Appendix B. Poles and bases made of other materials or having other dimensions must have written approval from the CGA Rules Committee.

7.4 Barrels

Fifty-five gallon unweighted plastic barrels shall be used, and they may not be structurally altered. Barrel covers may be used.

7.5 Rakes

Rakes are required for raking around the obstacles and for raking around the course for a Keyhole Race.

7.6 Lime

- A. A bag of non-caustic type lime or flour is required for preparing Keyhole Race, and for spotting the position of poles and obstacles.
- B. Other non-caustic marking materials such as marking paint, gypsum, or dolomite may be used instead of lime for line markers.

7.7 Pails, Sand and Flags

These items are required for a Figure 8 Flag Race. Pails shall be 10-quart rubber or plastic with the opening at the top approximately 10 inches in diameter and the approximate height of 10 inches; two are required. The sand must be 20 grit in size and shall be dry. Sakrete play sand in paper bag will be an acceptable Figure 8 Flag sand. It is more readily available, easy to find, comes in 50 lb. bags and will eliminate the confusion and allow for consistency among districts. The pails shall be filled to $\frac{3}{4}$ level. Show management shall have sufficient sand available to refill each pail to the $\frac{3}{4}$ level in the event of spillage from one run to another. 3 flags are made by solidly affixing a 1' square cloth to the center of a 2' dowel with is $\frac{1}{2}$ " in diameter; both ends are sharpened to a dull point. Each flag shall be a different color.

7.8 Jumps

Jumps shall be constructed as described in Appendix C.

7.9 Ribbons

Ribbons for the ribbon race are made of crepe paper. Each ribbon shall be 4' long and 1 ½" to 4" wide. The width of the ribbons shall be identical for each team. A fresh ribbon shall be used for each team.

7.10 Speedball Race

The speedball cone shall be made of a large pylon with the top cut down to a 5" diameter opening. The cone may be painted any color with contrasting strip or design, and measure an overall height of 24" (see Appendix A). The balls used for speedball must be standard golf balls of any color.

7.11 Keyhole

The 'wings' placed on the keyhole measure six (6) inches.

Section 8: Gymkhana Events Course Layouts and Patterns

8.1 General Information

This section provides information on the course layout, course pattern, and penalties associated with specific events. General information applicable to these events is given in other sections of this rule book. In particular refer to Section 4 for general procedure and Section 5 for penalties. Equipment, materials and timing specifications are discussed in Section 7.

- A. The course diagrams that follow are intended to depict the proper turning direction around obstacles. The straight-line method of proceeding from one obstacle to another, however, is not mandatory. A rider may be considered on course so long as he/she remains within the confines of the arena and negotiates all obstacles in the correct direction without recrossing the timing line until the course is complete.
- B. In all gymkhana events there must be at least 15' between any obstacle to be turned and the fence or rail. All measurements shall be made from the center position of the obstacle except for keyhole Race which is 25 feet from the center.
- C. The distance from the running starts shall be exactly 80' from the timing line. Unless the fence is used as the 80' foul line, that line must be marked with either a non-caustic type of lime or flour. Poles may be used to mark the foul lines for reverse riders. This distance can vary at CGA State sponsored shows ONLY, and notification shall be given to the riders if that occurs.
- D. The timing poles shall be 30' in width for all events unless otherwise specific in the event diagram.
- E. The minimum size of the arena in order to be able to run all 13 CGA events is 120' wide by 250' long. In this case, no more than one rider shall be in the arena at one time.

NOTE: More than one rider may be in the arena at one time if the arena is at least 120' x 270'. In this case, the beginning of the 80' foul line should start from a point at least 20' from the entrance gate and all riders in the arena who are not currently participating in the event shall remain mounted and keep their mounts in the 20' area behind the back portion of the foul line. Any rider desiring to be the sole rider in the area during the running of the event must be afforded the opportunity.

8.2 Events for Individual Contestants

In all of the following events for individual contestants, the same procedure is to be followed as per the instructions in the Sections 4.2 through 4.8.

8.3 Course Layout Diagram

BARRELS

Obstacles:

- 2 Poles
- 3 Barrels

Course Layout :

Note: Timing Poles are set approximately 6" behind the timing line so they won't interfere with the electronic beam.

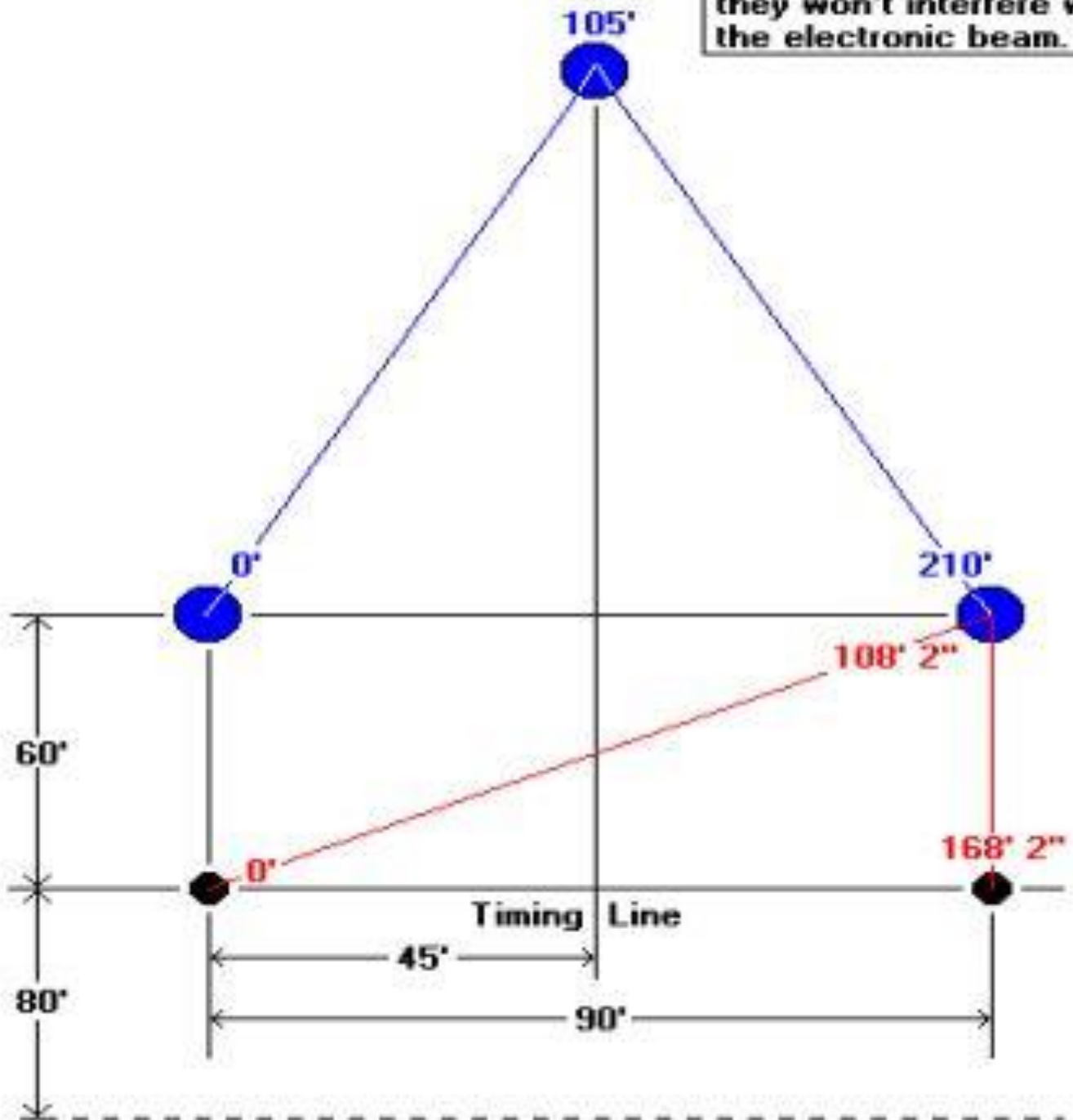

BIG "T"

Obstacles:
 5 Poles
 2 Barrels

Note: Timing Poles are set approximately 6" behind the timing line so they won't interfere with the electronic beam.

Course Layout :

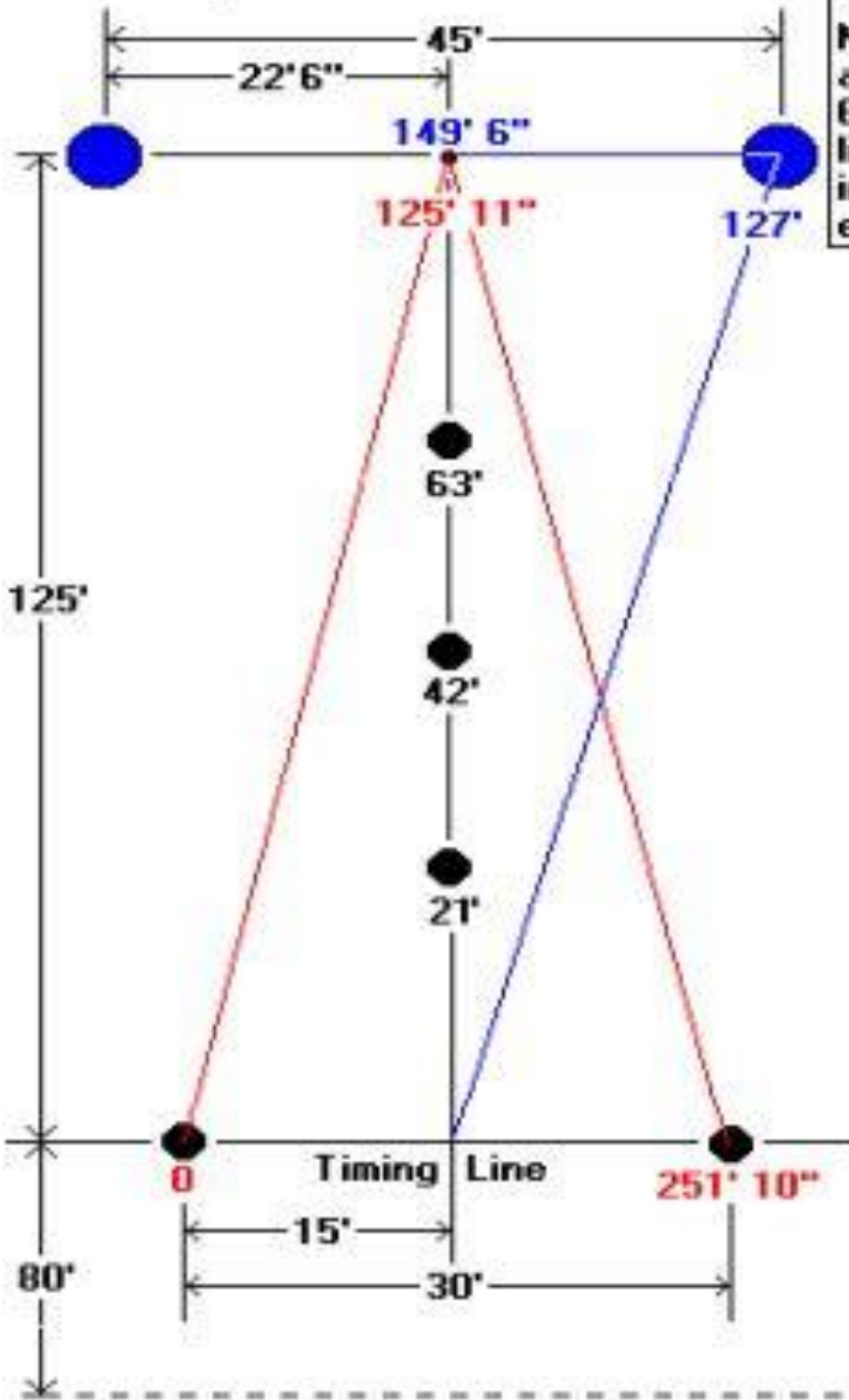

BIRANGLE

Obstacles:

4 Poles

Note: Timing Poles are set approximately 6" behind the timing line so they won't interfere with the electronic beam.

Course Layout :

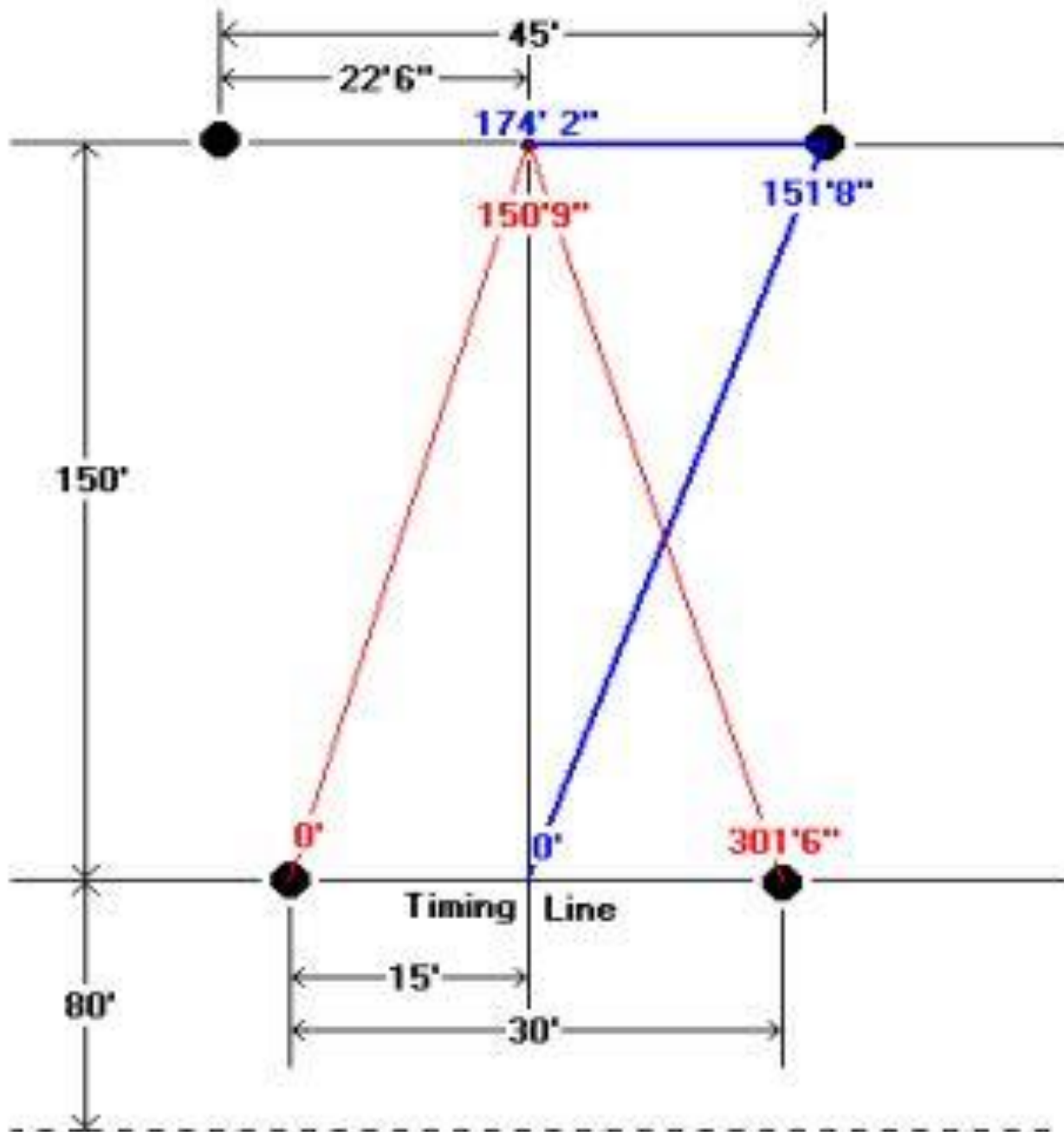
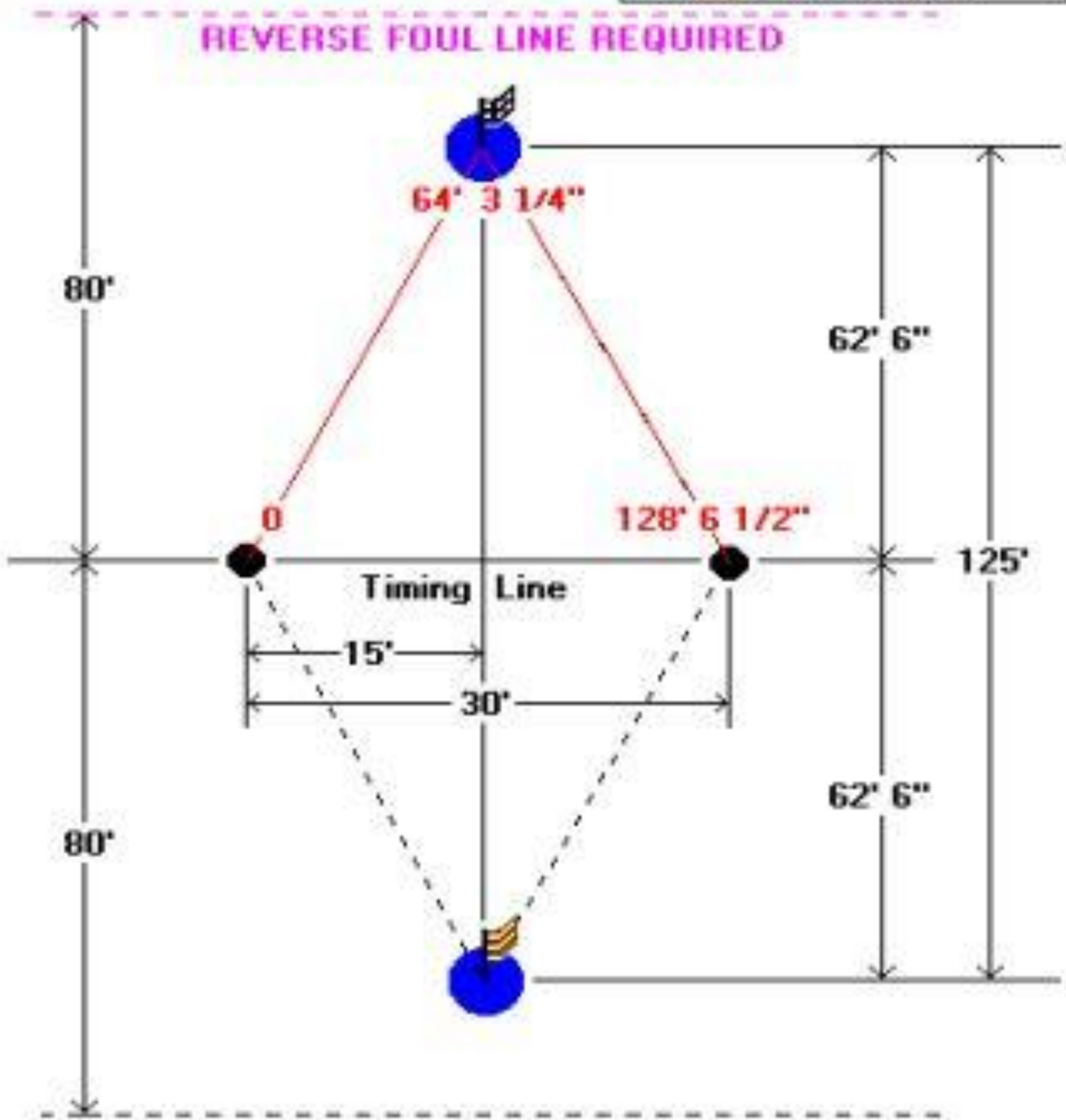

FIGURE 8 FLAGS

Obstacles:
2 Barrels, 2 Poles 2 Pails,
3 Flags, Sand
Note: Timing Poles are set approximately 6" behind the timing line so they won't interfere with the electronic beam.

Course Layout :



HURRY SCURRY

NO LEAD LINERS

Obstacles:

3 Jumps

3 Poles

Note: Timing Poles are set approximately 6" behind the timing line so they won't interfere with the electronic beam.

Course Layout :

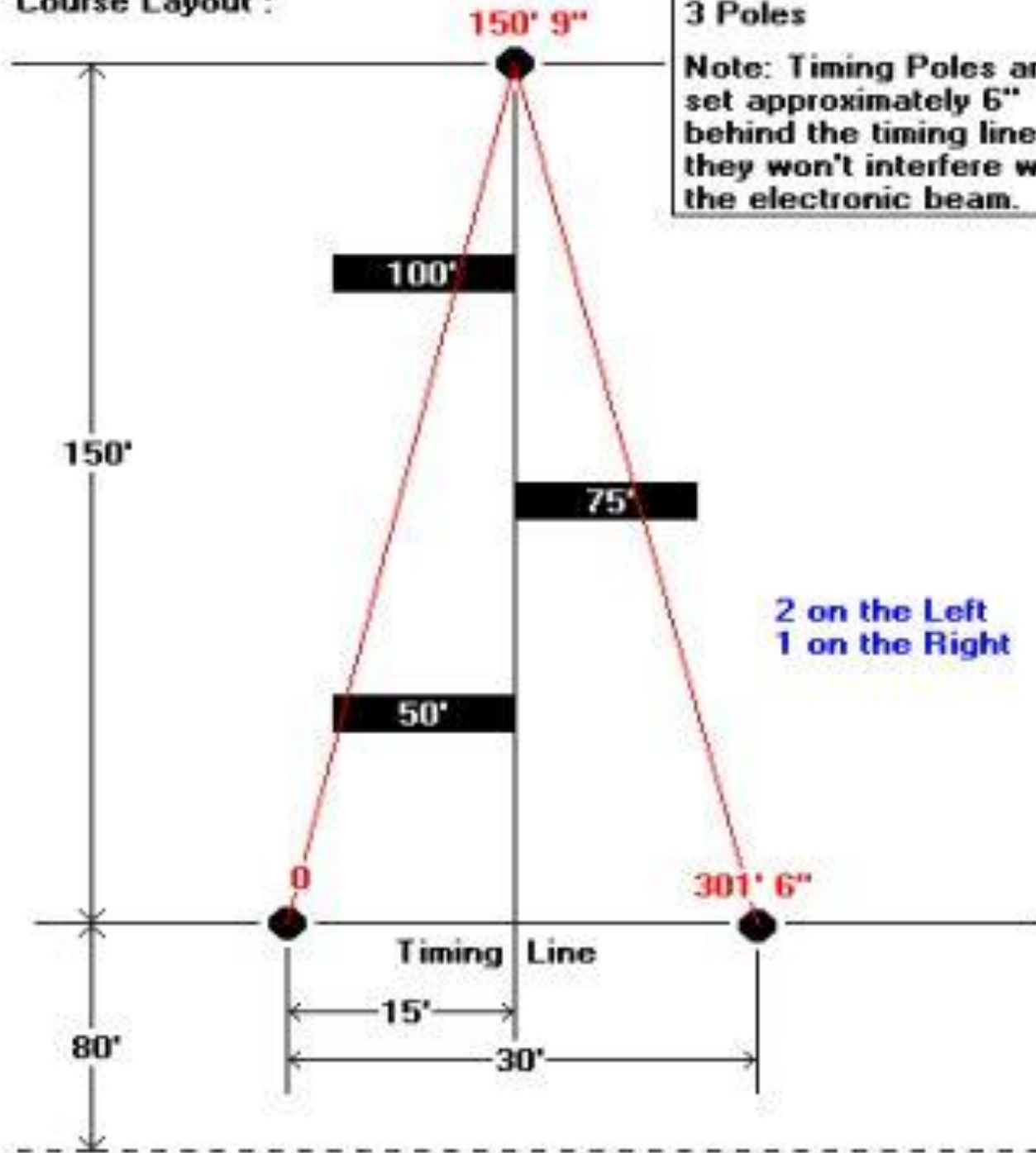

2 on the Left
1 on the Right

KEYHOLE

Course Layout :

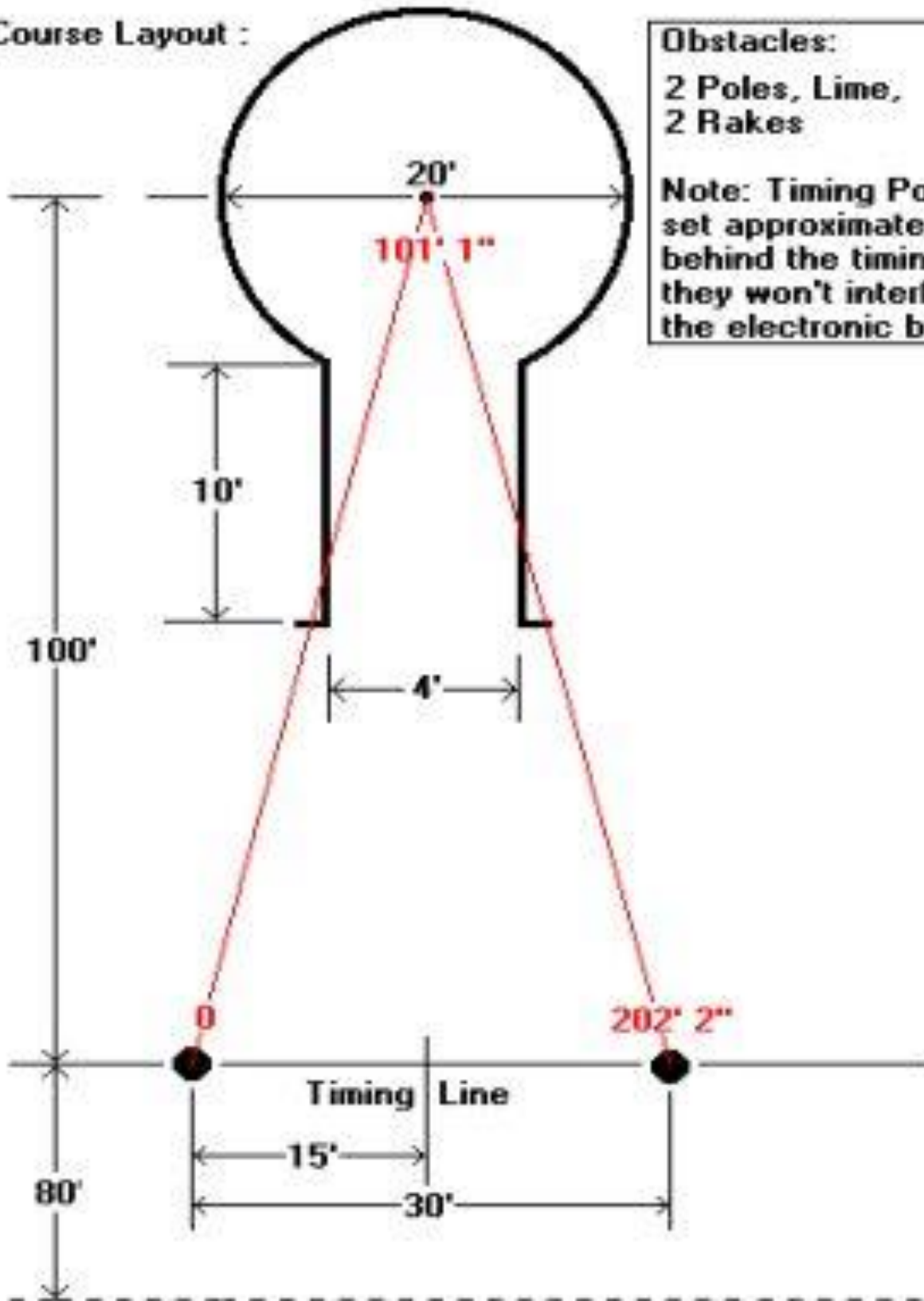

Obstacles:

2 Poles, Line,
2 Rakes

Note: Timing Poles are set approximately 6" behind the timing line so they won't interfere with the electronic beam.

POLES 1

Course Layout :

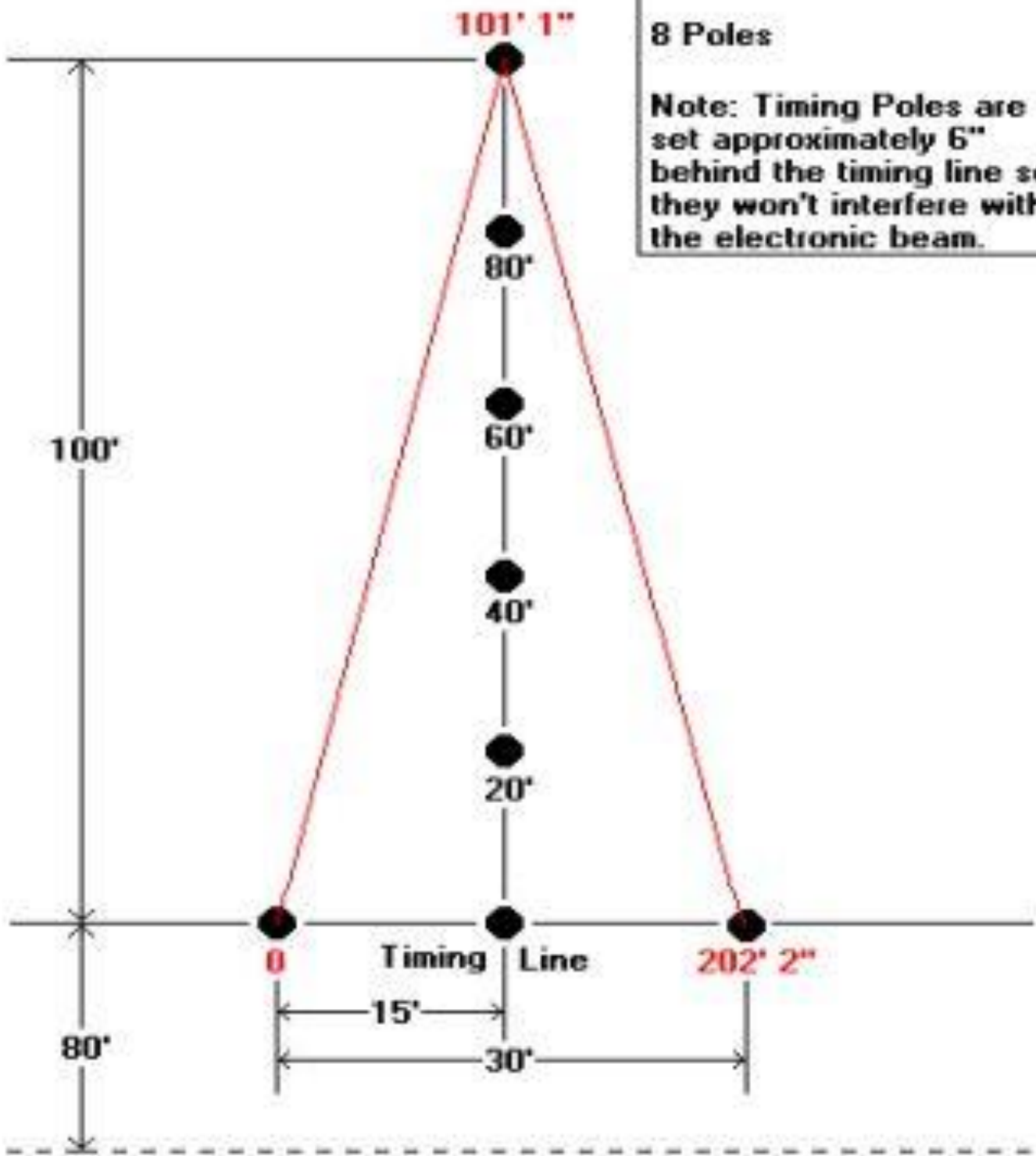

Obstacles:
8 Poles
Note: Timing Poles are set approximately 6" behind the timing line so they won't interfere with the electronic beam.

POLES 2

Course Layout :

Obstacles:

8 Poles

Note: Timing Poles are set approximately 6" behind the timing line so they won't interfere with the electronic beam.

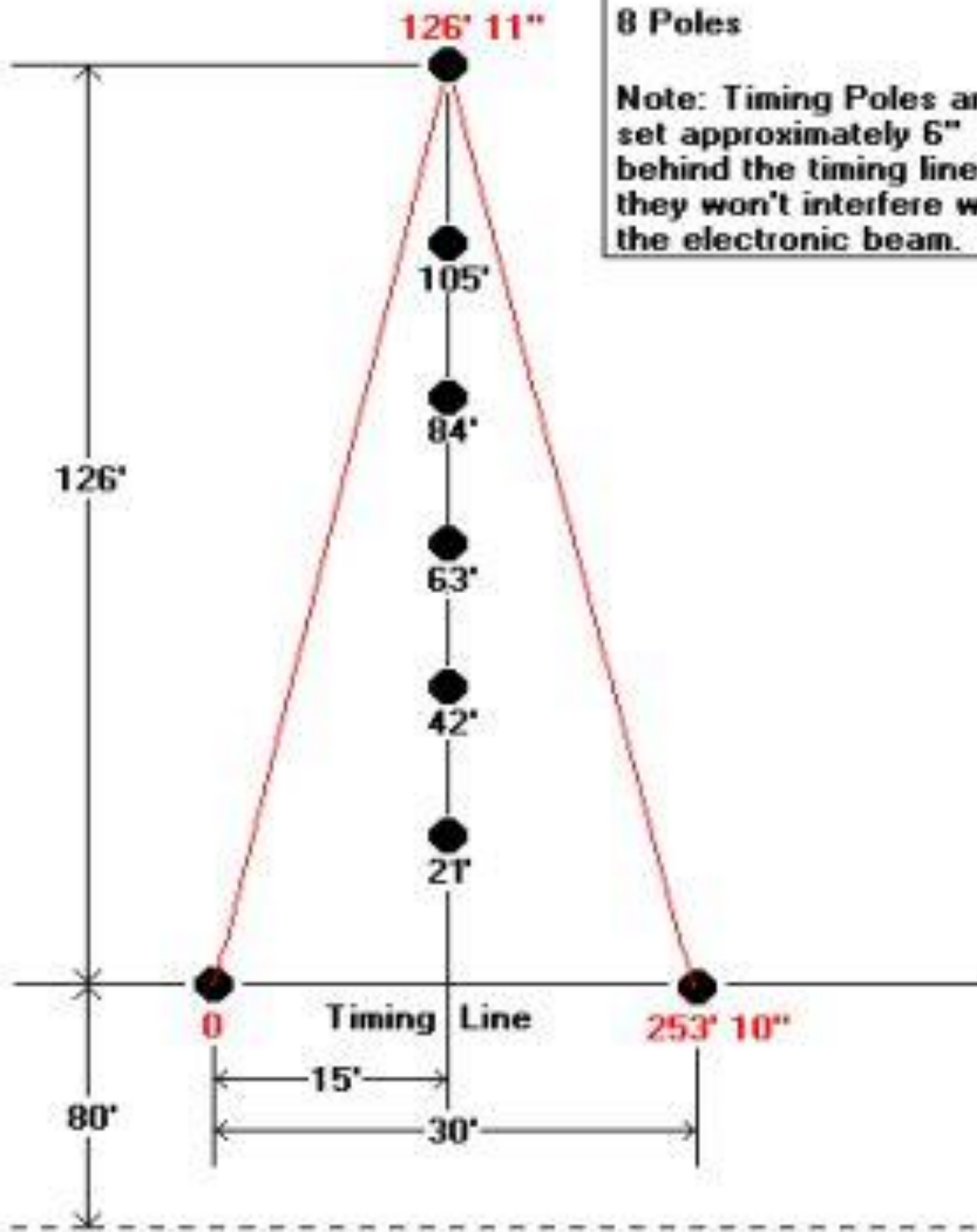

QUADRANGLE

Course Layout :

Obstacles:

6 Poles

Note: Timing Poles are set approximately 6" behind the timing line so they won't interfere with the electronic beam.

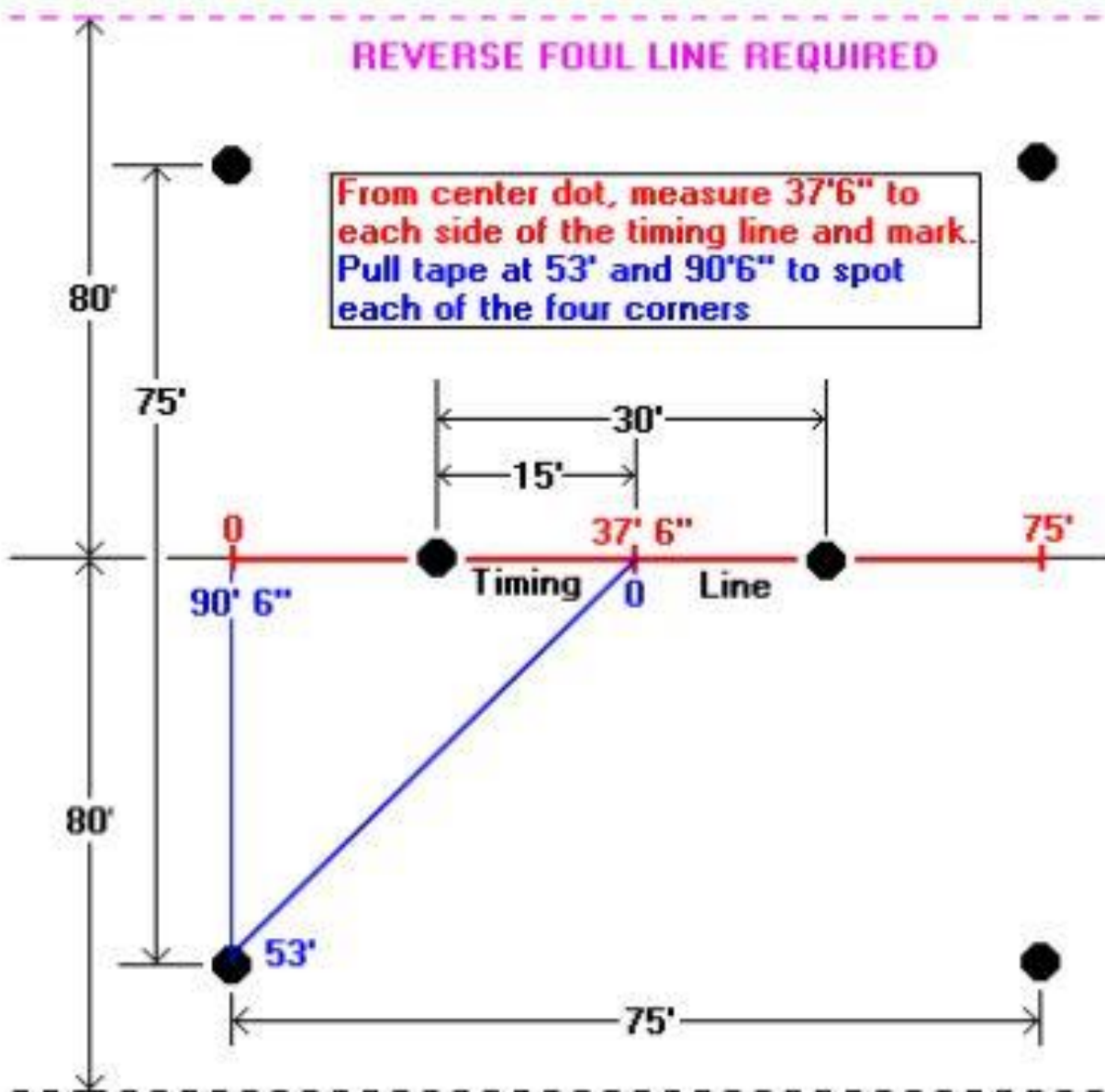

SINGLE STAKE

Course Layout :

Obstacles:
3 Poles

Note: Timing Poles are set approximately 6" behind the timing line so they won't interfere with the electronic beam.

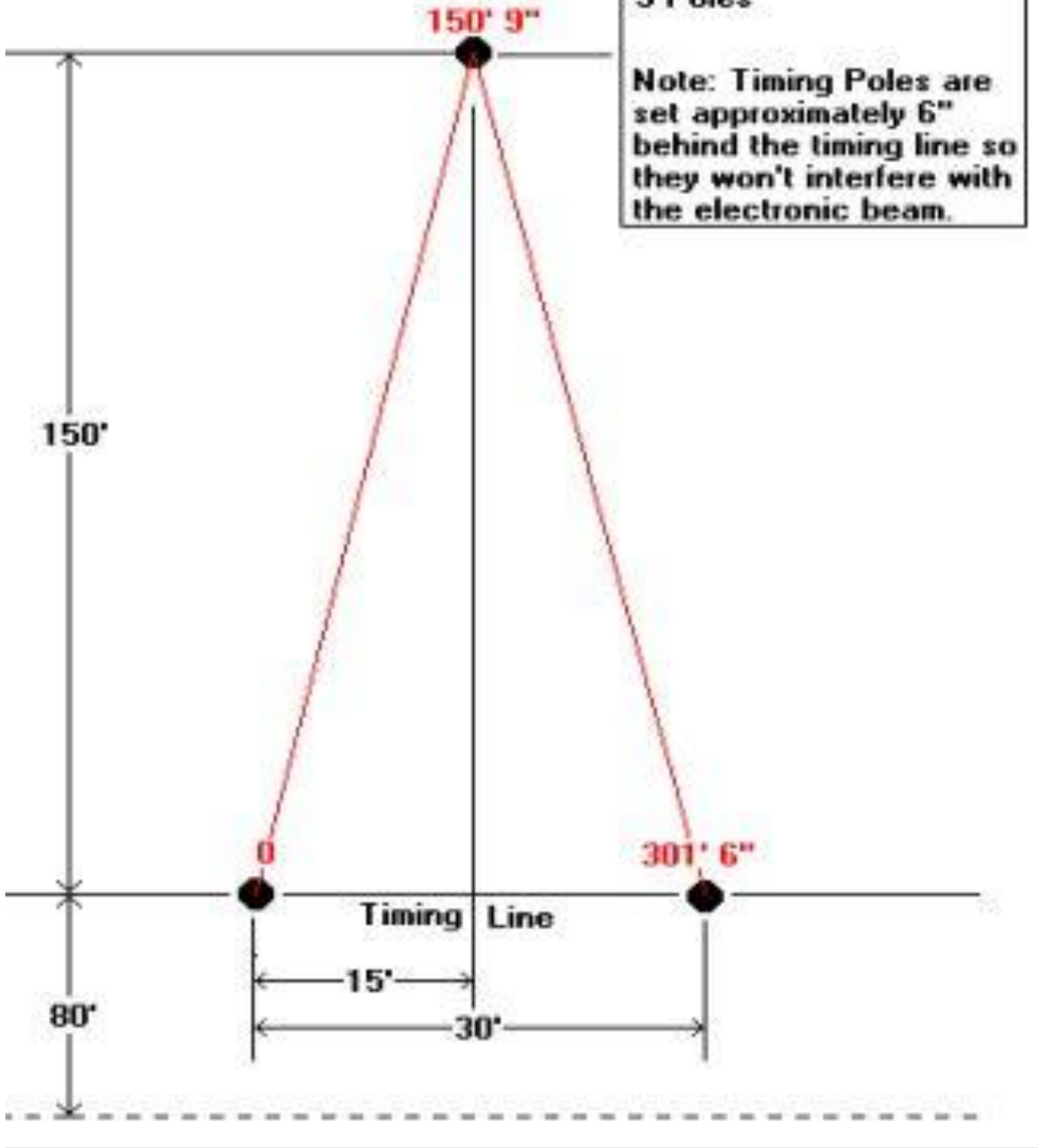

SPEED BALL

Course Layout :

See Appendix A
for Cone Construction

Obstacles:

2 Poles Golf Balls
1 Cone

Note: Timing Poles are set approximately 6" behind the timing line so they won't interfere with the electronic beam.

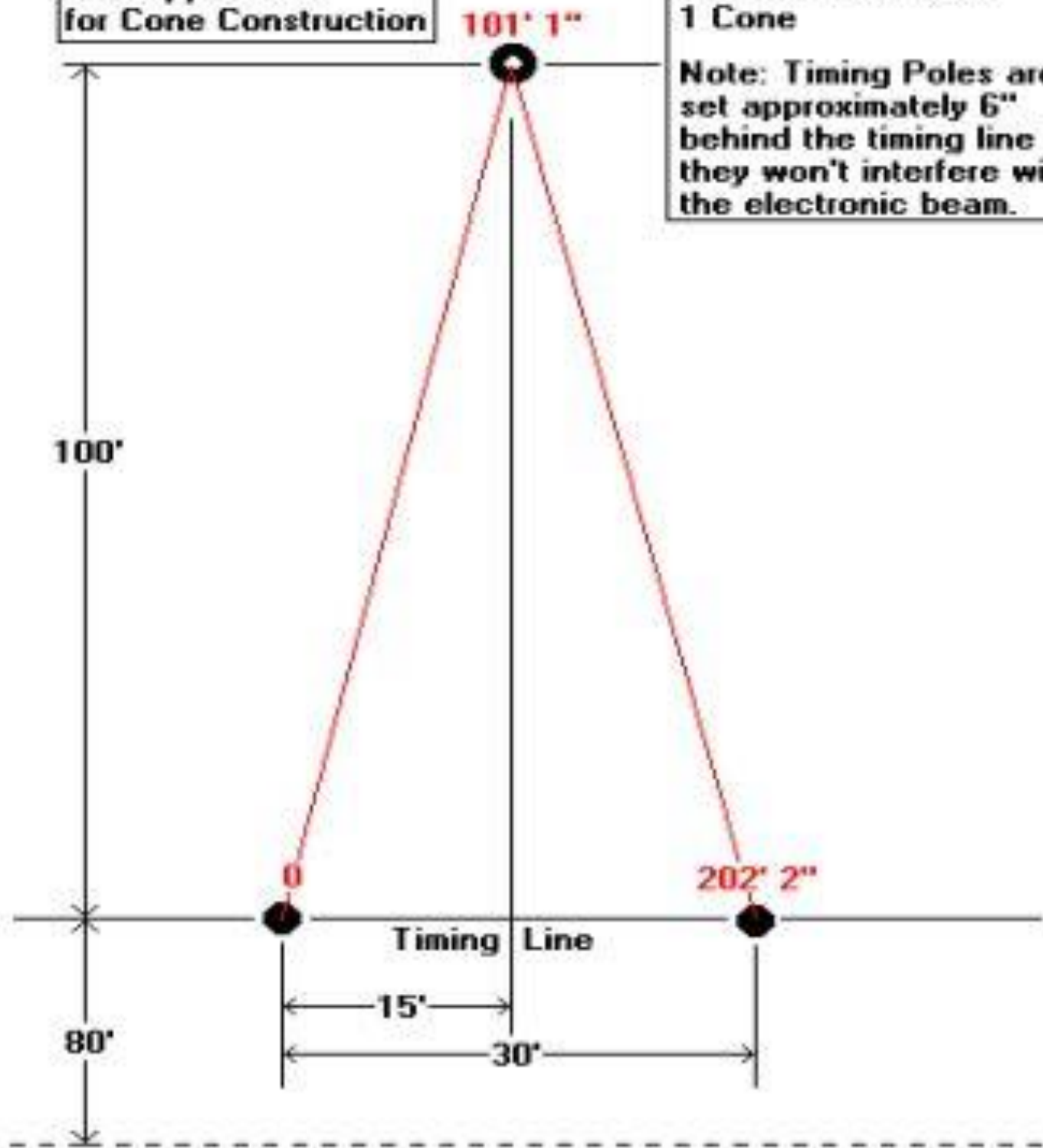

SPEED BARRELS

Course Layout :

Obstacles:

2 Poles
3 Barrels

Note: Timing Poles are set approximately 6" behind the timing line so they won't interfere with the electronic beam.

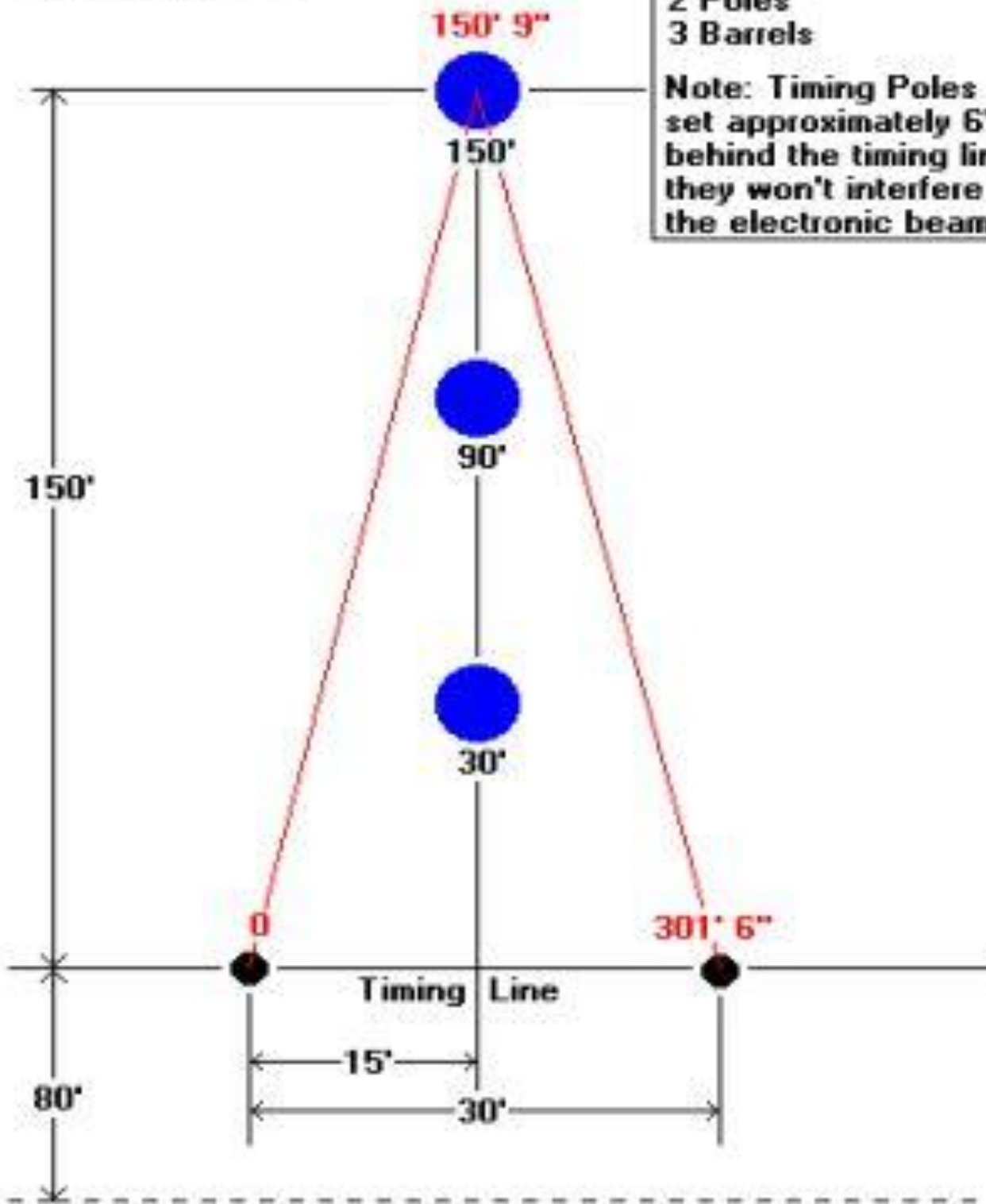

8.4 Course Pattern Diagrams

Barrels

Go through the timing line, go to either barrel #1 first, making a right turn and then to barrels #2 and #3, making left turns; or to barrel #2 first, making a left turn and then to barrels #1 and #3, making right turns; then return through the timing line.

1 Right turn and 2 left turns:

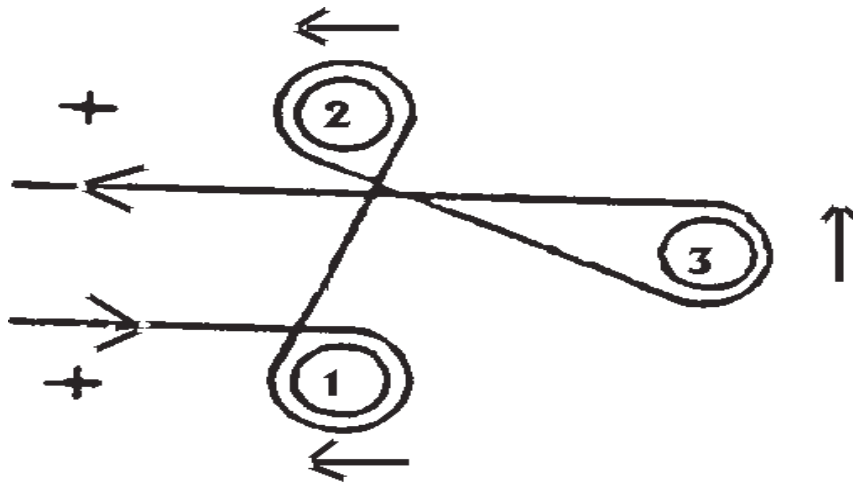

1 Left turn and 2 right turns:

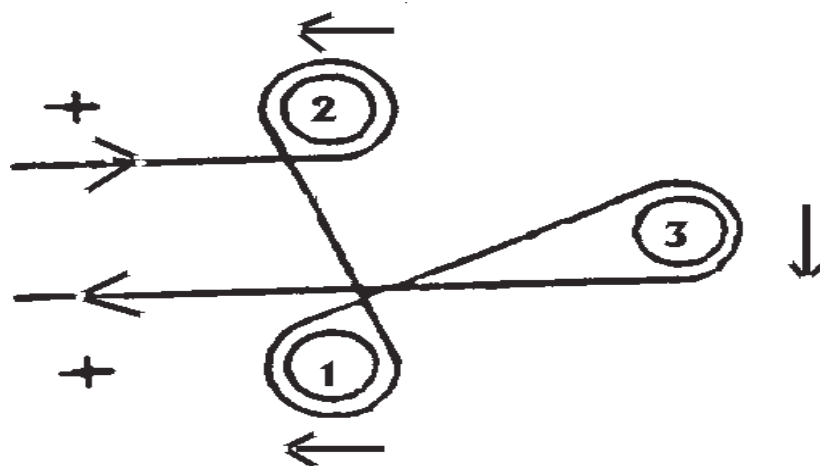

Big T

Go through the timing line, pass the first pole on either the left or the right, pass the next two poles on alternate sides. If the 3rd pole is passed on the right side, proceed to the barrel on your left, making a left turn and then a left turn around the other barrel. Then weave back through the three poles on opposite sides to pass through the timing line.

Note: If the first pole is passed on the right side, the two barrels will both be left turns. If the first pole is passed on the left side, the two barrels will both be right turns.

Left turn around each of the two barrels:

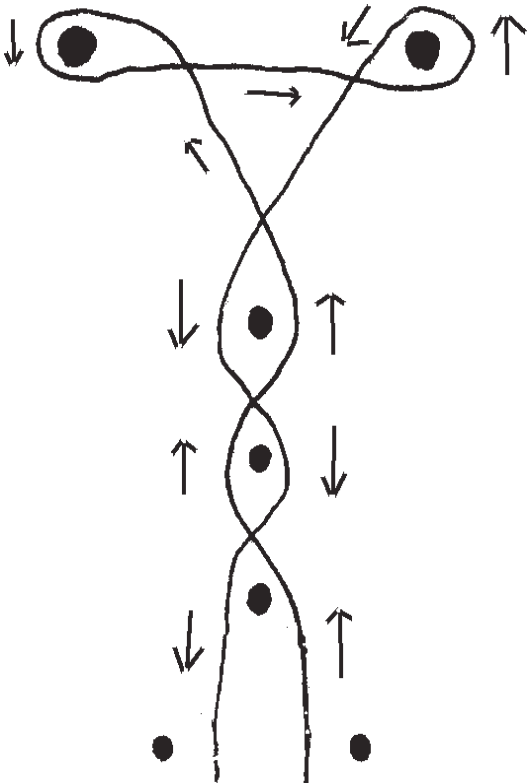

Right turn around each of the two barrels:

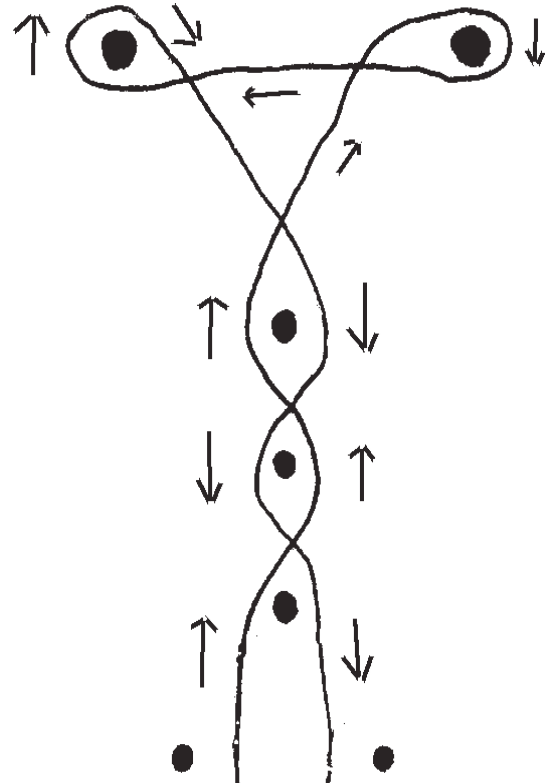

Birangle

Go through the timing line and run to the inside of either pole. Turn the pole and run to the second pole, turning in the same direction as the first pole. Return to timing line.

Two left turns:

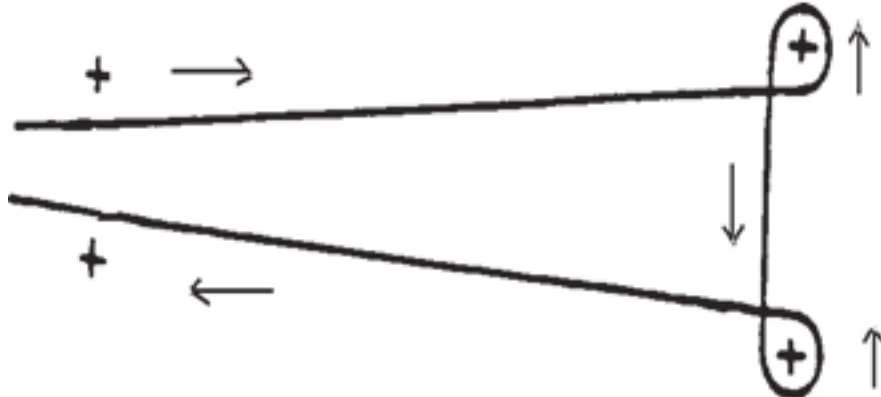

Two Right Turns:

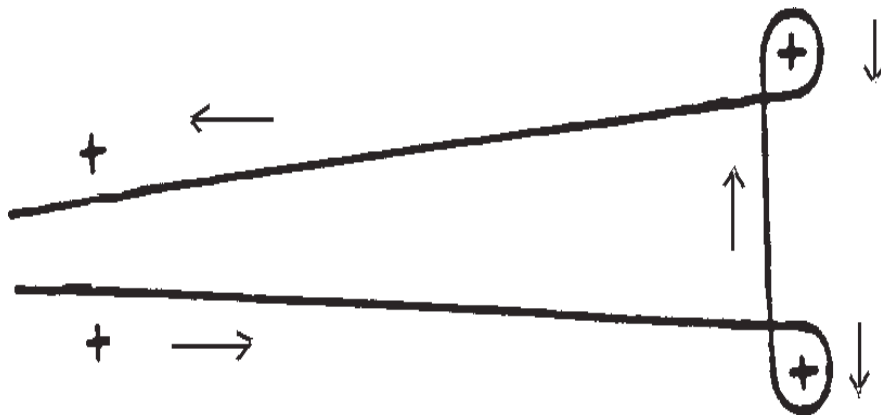
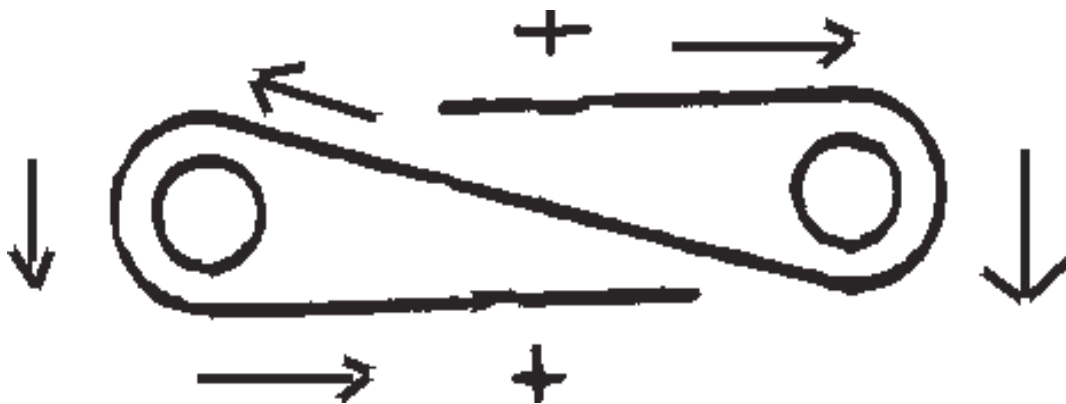

Figure 8 Flags

Start from either end of the course carrying a flag. Go through timing line and go around first barrel in either direction, exchange flags, then go around the second barrel, turning it in the opposite direction. Exchange flags and return to the timing line. The dowel portion of the flag must be in the pail and touching the sand. If the flag has fallen (laid over pail or barrel), but not touched the ground, the rider may recover it and place it in the pail. If the flag touches the ground, the rider is disqualified.

Special penalty: The rider will be disqualified for knocking over a pail or for using the flag as a club or bat.

Left turn around last barrel:



Right turn around last barrel:

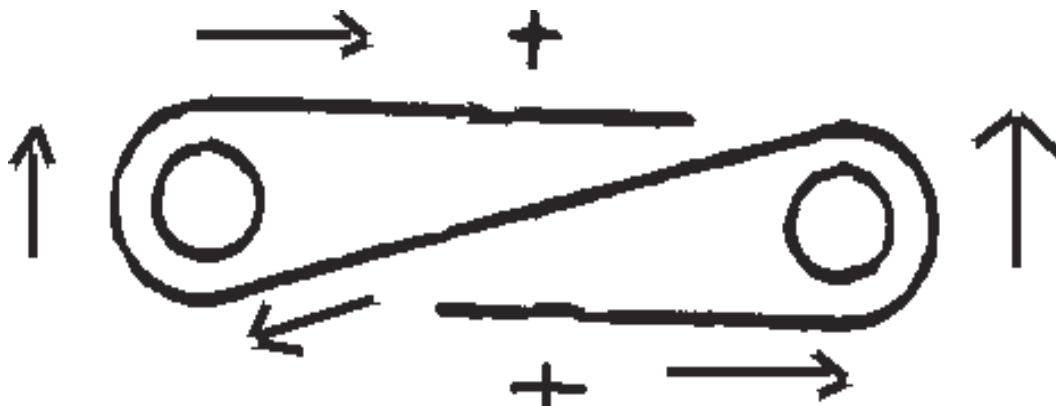
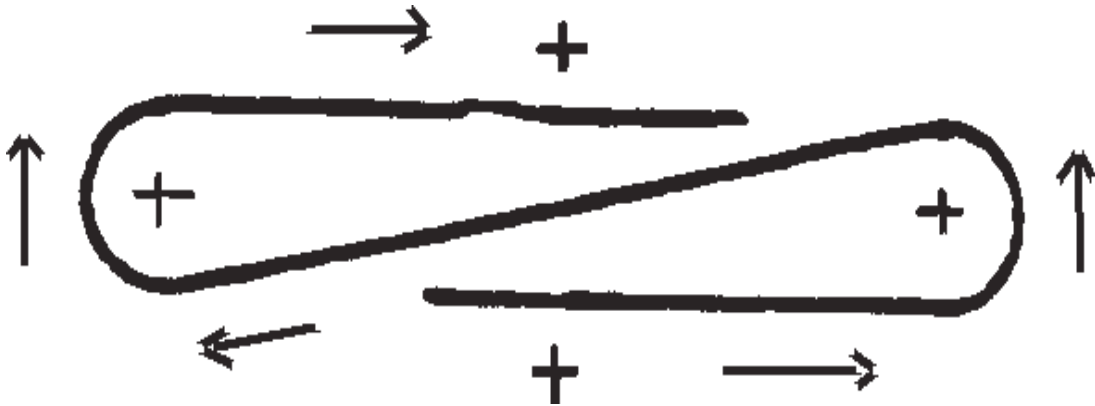

Figure 8 Stake

Start from either end of the course. Go through the timing line to the first pole. Go around the pole in either direction. Go across the timing line to the next pole and go around it in the opposite direction, then return across the timing line.

Left turn first:



Right turn first:

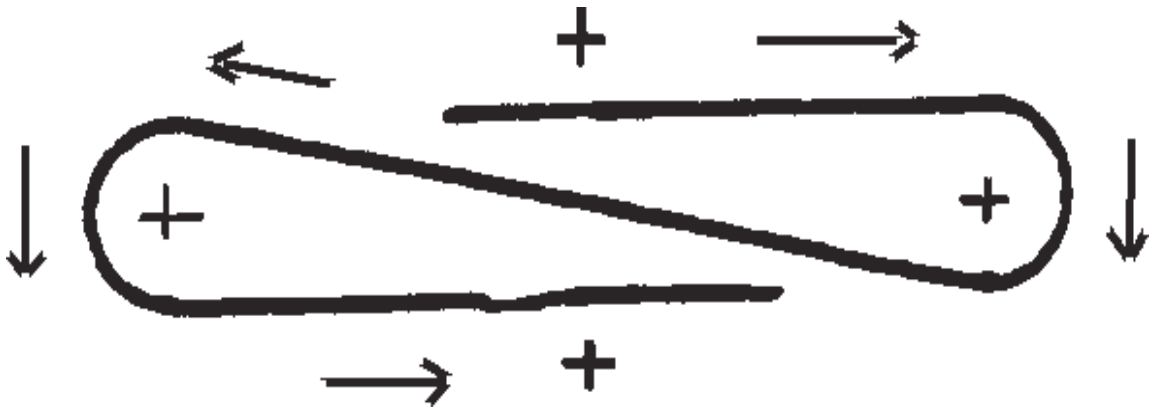

Hurry Scurry

Go through timing line and either go down left side making two jumps, a right turn around the pole and 1 jump, or go down right side making 1 jump, a left turn around the pole and two jumps, then go back across the timing line.

Special penalty: The rider will be disqualified if all four feet of the horse do not go over each jump and the course is not corrected.

2 Jumps first and right turn:

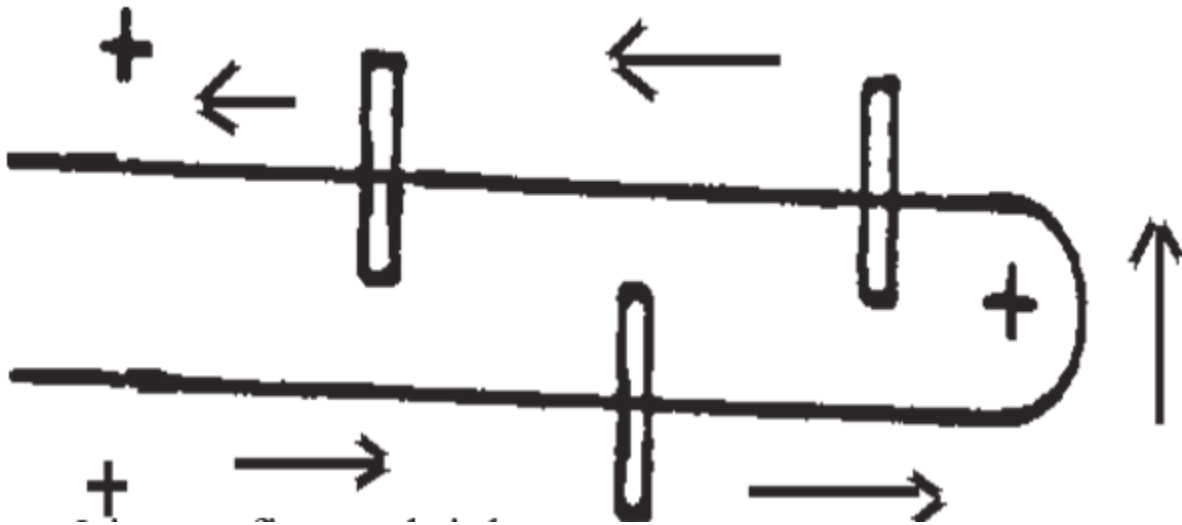

1 jump first and a left turn:

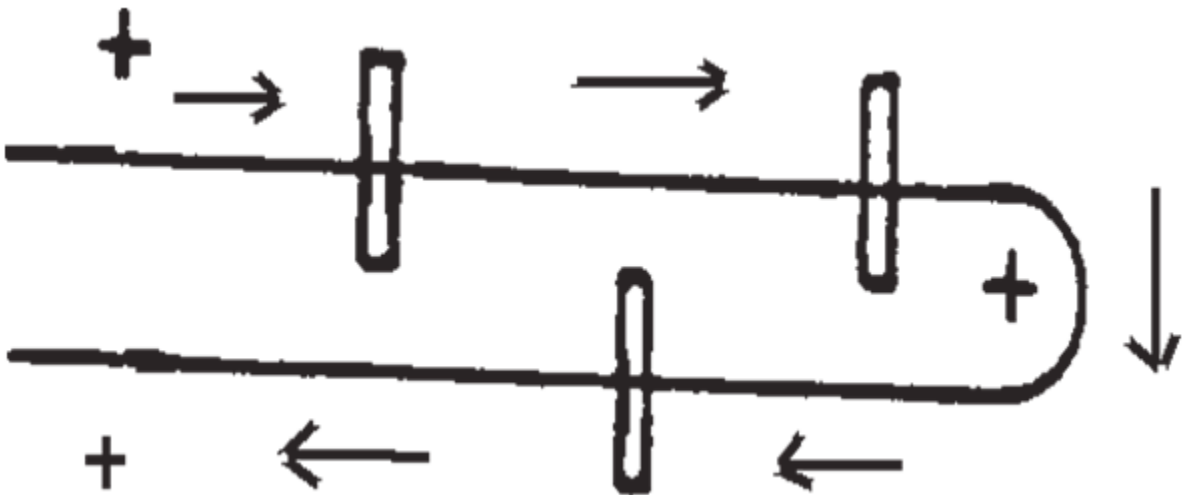

Keyhole

Go through the timing line, run into the circle of the keyhole, turn in either direction, and return through the timing line. All four of the horse's feet must enter the circle.

Special penalty: The rider will be disqualified if the horse's hoof touches the ground on or outside of any portion of the keyhole (circle or wings).

Note: A penalty judge shall be stationed near the keyhole and shall determine (by viewing hoof prints) the qualification of the ride. Such decision is final. Once or more assistants shall be stationed near the keyhole with rakes and will rake the disturbed area near the keyhole as needed.

Rider may turn in either direction in the keyhole.

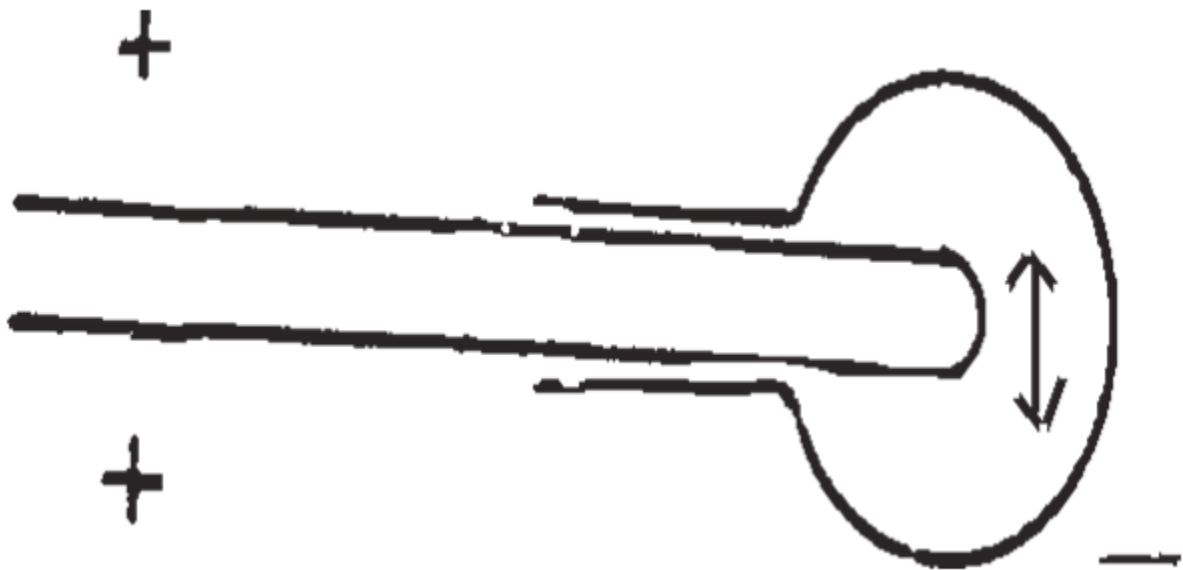

Pole Bending I

Go through the timing line, pass the first pole on either side, pass the successive poles on alternate sides, turn the last pole and return, passing each pole on alternate sides.

Left turn at last pole:

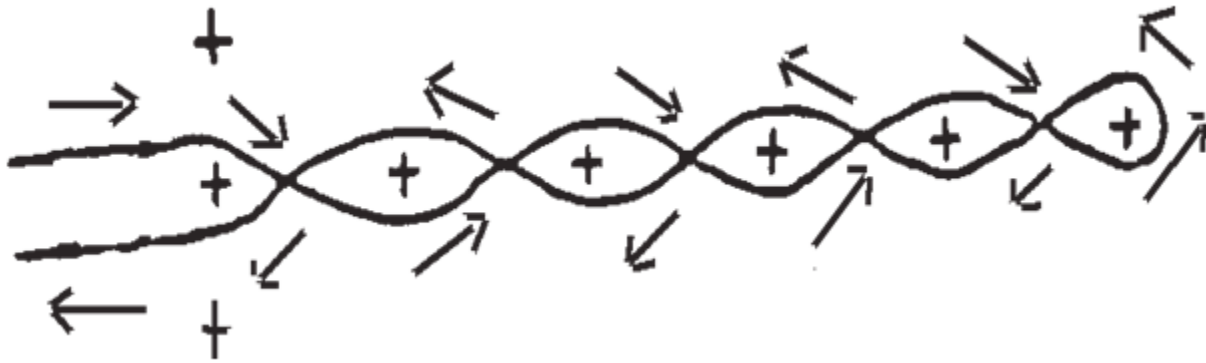

Right turn at last pole:

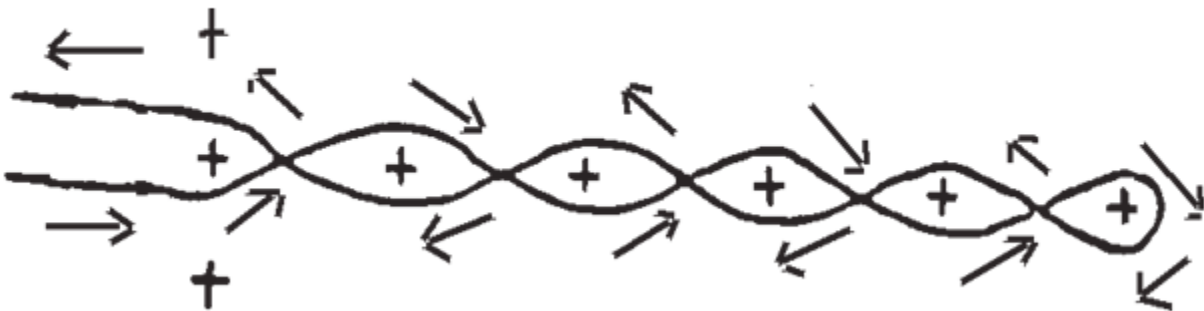

Pole Bending II

Go through starting line, go along either side of the poles to the last pole, turn around the last pole, pass successive poles on alternate sides, turn around first pole, continue to pass successive poles on alternate sides, turn around the last pole and go along the side of the poles to the timing line.

Right turn at last pole:

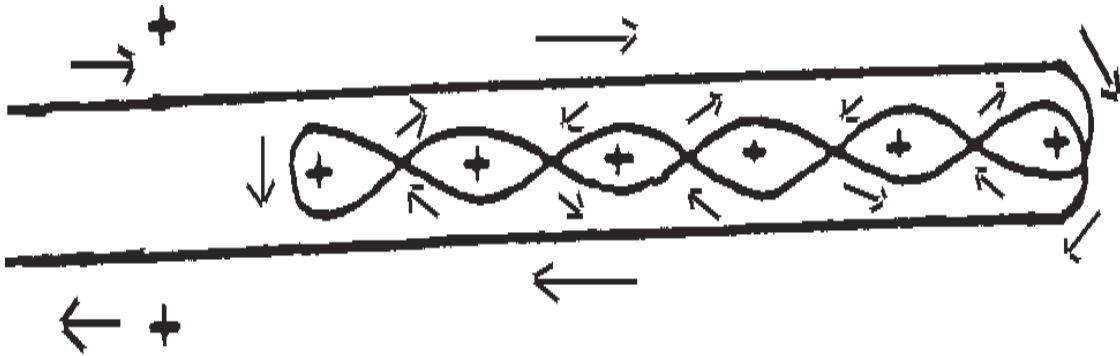

Left turn at last pole:

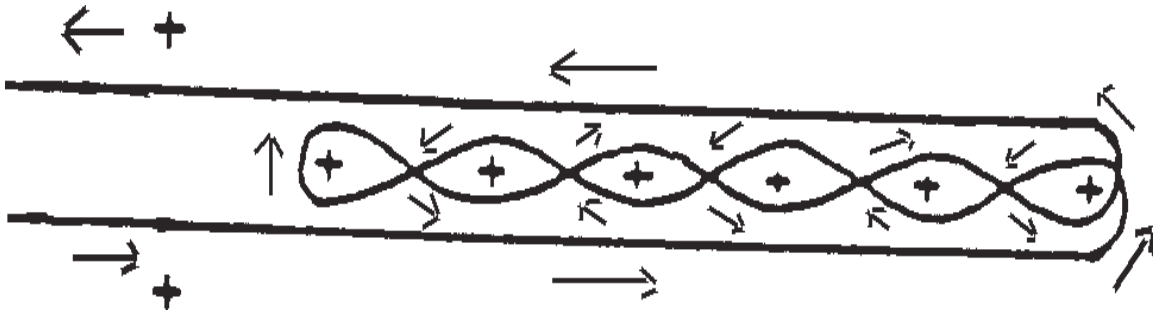

Quadrangle Stake

Starting from either end, go through the timing line, turn the first pole from the inside, turn the second pole in the same direction, cross the timing line and turn the third pole from the inside in the opposite direction as the first two poles, turn the fourth pole in the same direction as the third pole, pass back through the timing line.

Left turns first:

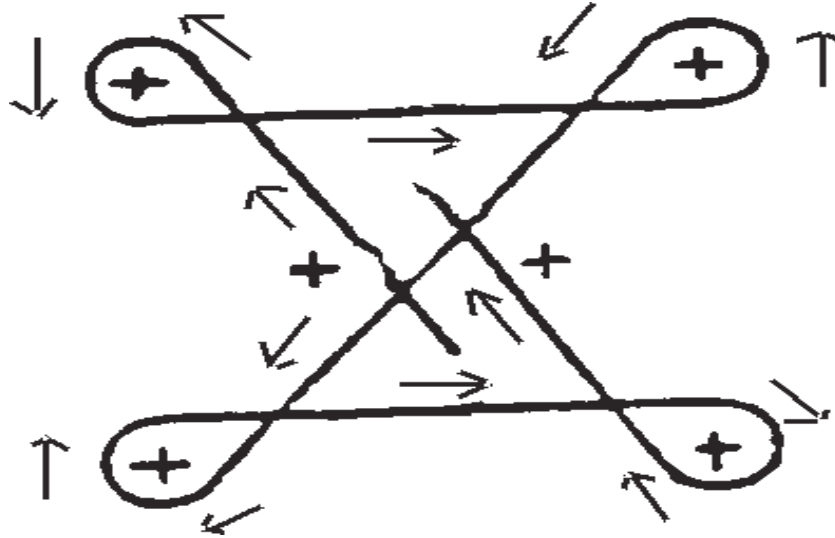

Right turns first:

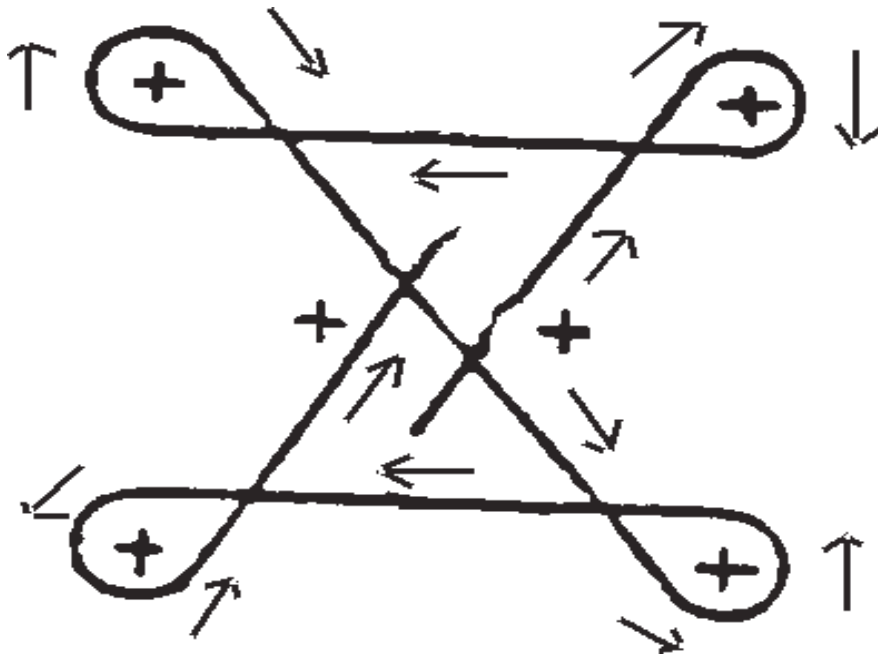

Speed Ball

Go through timing line to cone. Turn the cone in either direction, dropping the golf ball in the cone. Go back through timing line.

Special Penalty: A rider will be disqualified if the golf ball does not go inside the cone or if the cone is knocked over. Any action by the horse or rider that causes the ball to be outside the cone at the end of the ride shall be a “no time” ride. The cone shall be set on flat ground with no openings underneath the edges of the cone. If the ball rolls out from under the cone because of uneven ground, this shall be considered an illegal course, and the rider shall be given a reride.

A rider may turn left or right around the cone.

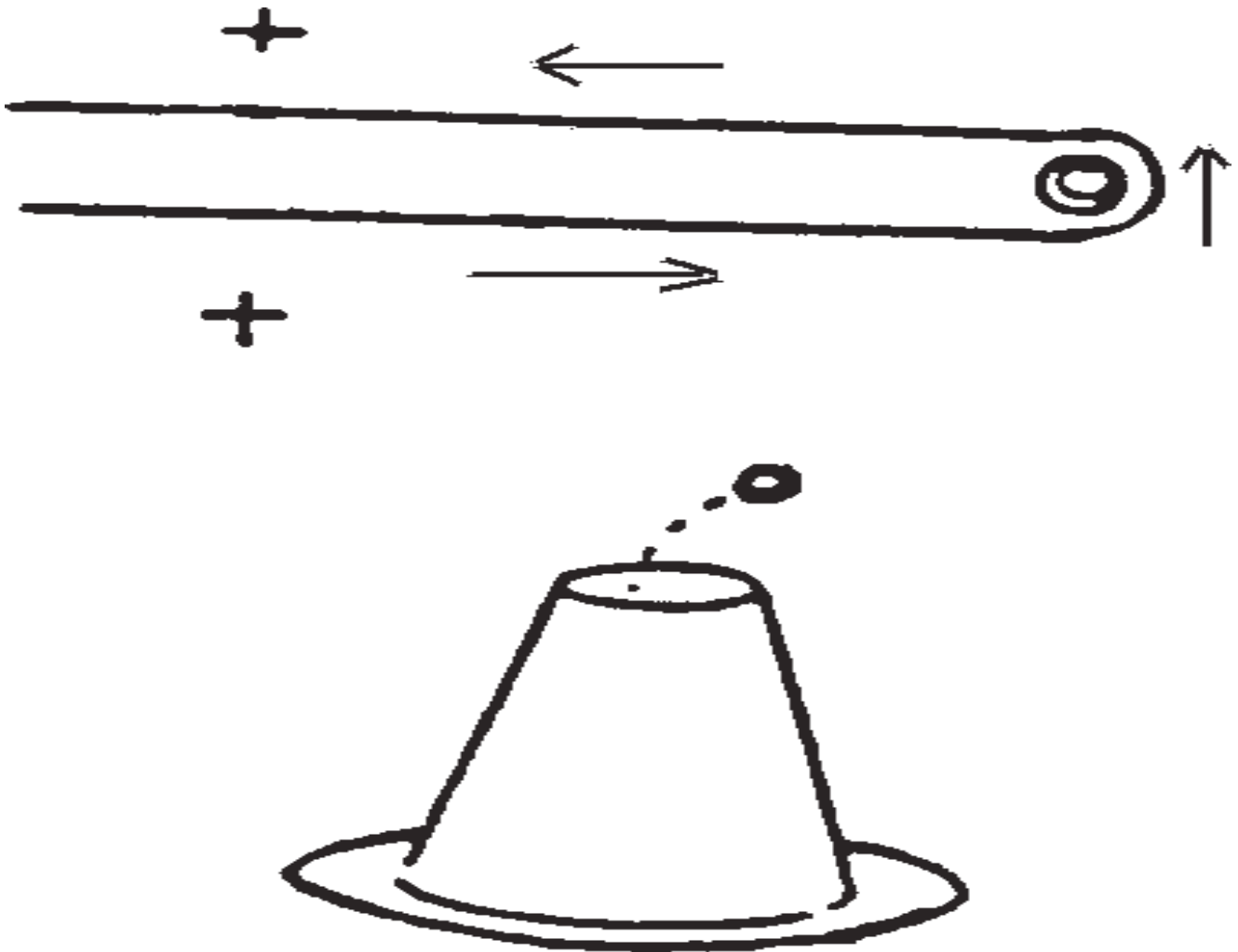

Speed Barrels

Go through timing line, pass first barrel on either side, pass the succeeding barrels on alternate sides, turn around last barrel, pass remaining barrels on alternate sides, go through timing line.

Left turn around end barrel:

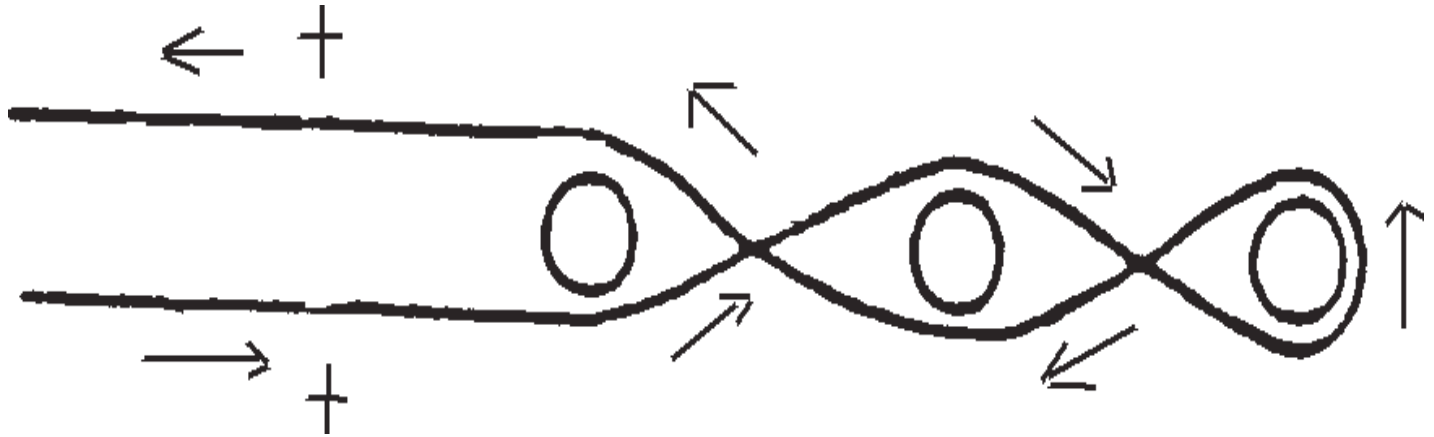

Right turn around end barrel:

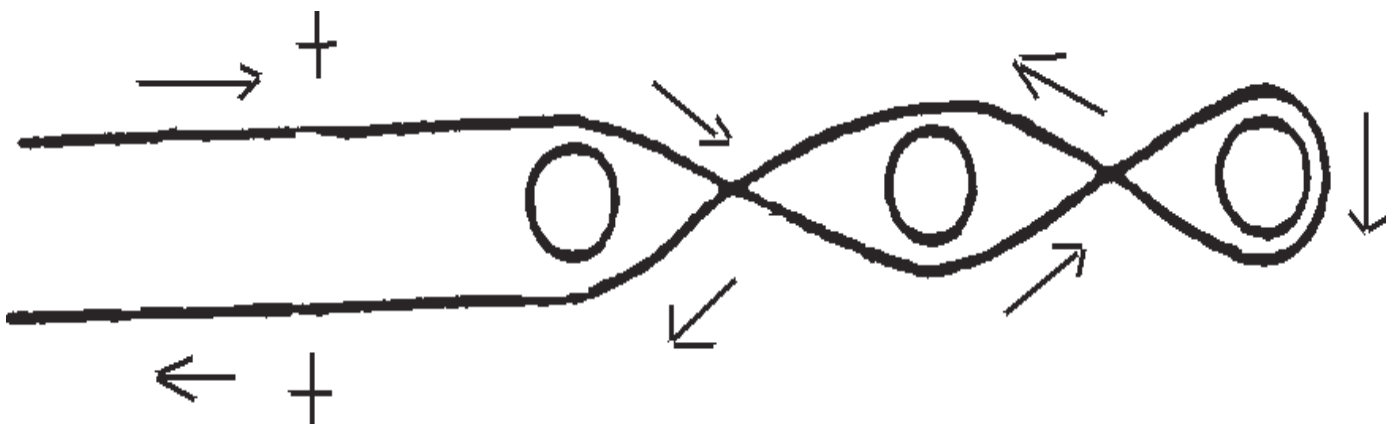

Single Stake

Go through timing line to pole, turn pole in either direction, return across timing line.

Left turn around pole:

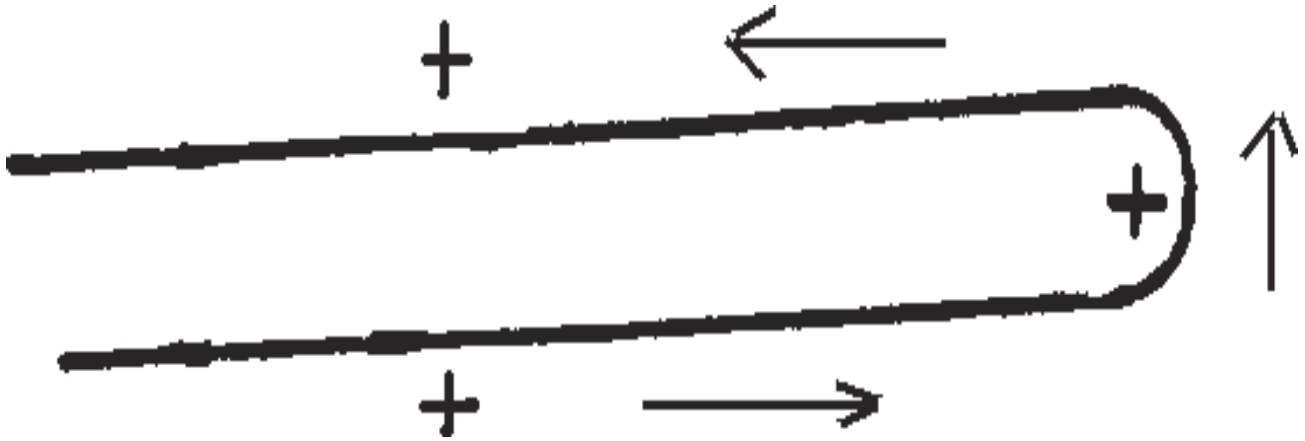

Right turn around pole:

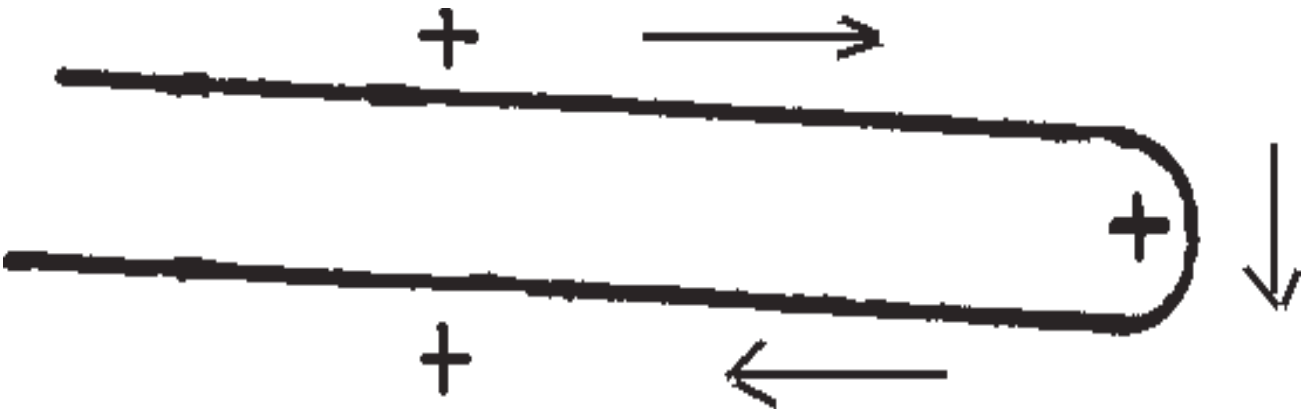

8.5 Team Events

Riders will be notified when the course is ready. After the last rider completes the course, the team must acknowledge the judge and wait for the judge's signal to leave the arena.

RESCUE RACE

Course Layout:

Obstacles:

4 Poles

Notes: Timing Poles are set approximately 6" behind the timing line so they won't interfere with the electronic beam.

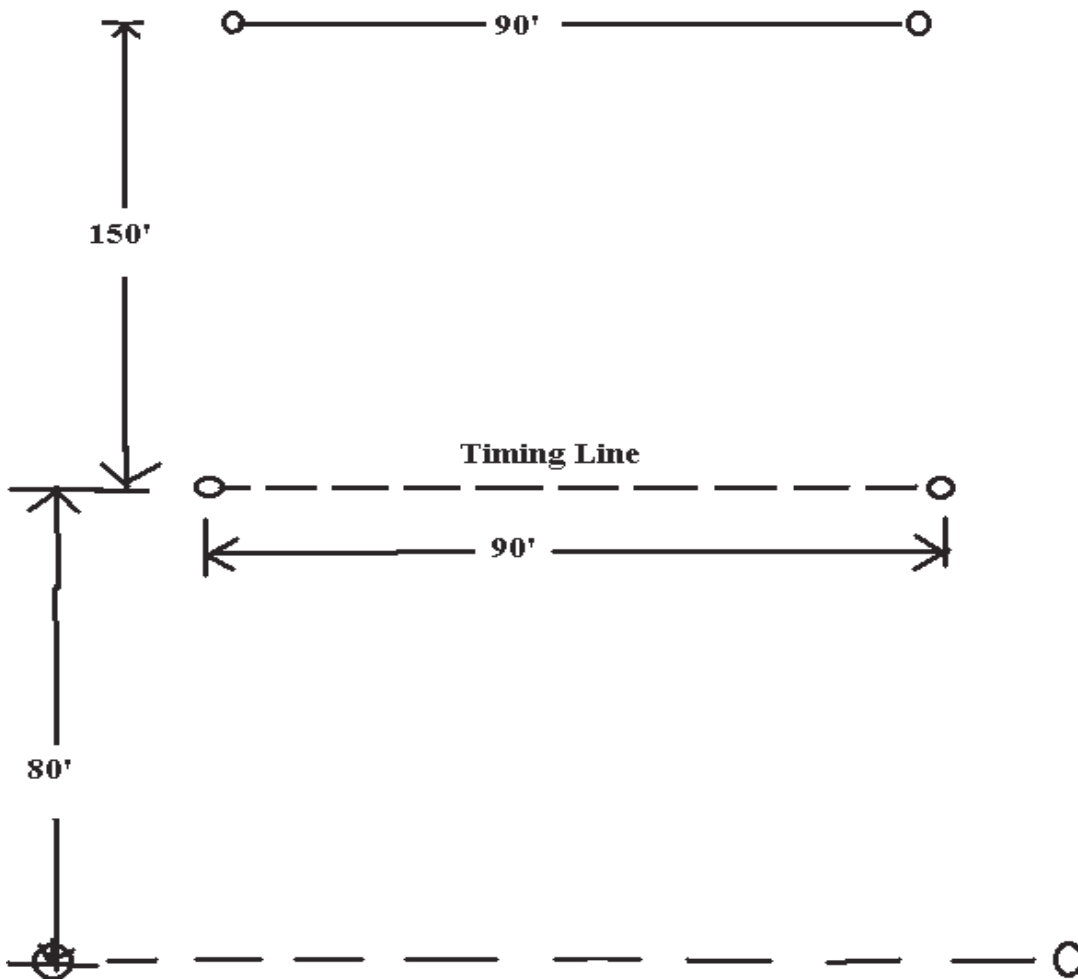

Rescue Race Course Pattern: The “picked up” member of the team takes his/her place behind the foul line. The mounted member of the team goes through the timing line and the foul line, turns in either direction as the “picked up” partner jumps onto the horse behind the saddle. Both riders then return to the timing line.

Special penalties: The “pick up” partner must be astride the horse (behind the saddle) before passing the foul line and must remain astride the horse and behind the saddle until the team passes over the timing line or the team will be disqualified. ***In the event the “pick up” partner falls off after crossing the foul line, they may recross the foul line and remount to correct the course.*** A rider is considered astride if one knee is on or across the center line of the horse’s back and no portion of the rider is touching the ground. A rider may not be the “picked up” partner on more than one team or they will be disqualified. Helmets are mandatory for both the rider and the “picked up” partner. Participants in Rescue Race must be at least 12 years of age as of January 1st of the current year.

RIBBON RACE

Course Layout:

Obstacles:

3 Poles

Ribbons

Notes: Timing Poles are set approximately 6" behind the timing line so they won't interfere with the electronic beam.

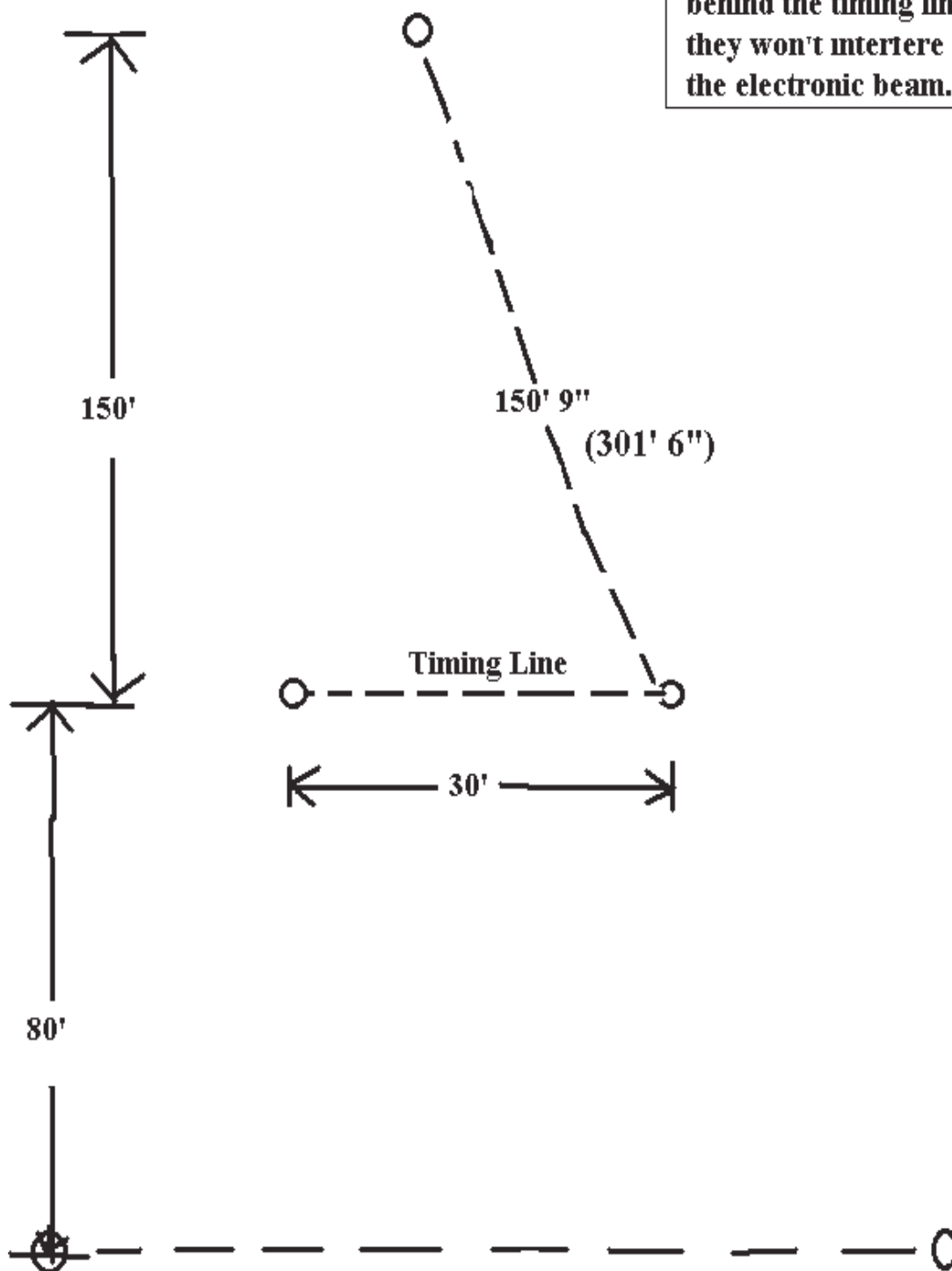

Ribbon Race Course pattern: A piece of crepe paper (4' long and 1 1/2" to 4" wide) is held between two riders as they cross the timing line, run to the pole, circle it in either direction and return to the timing line, still retaining their hold on the ribbon without breaking it or letting go of it.

Special penalties: The team shall be disqualified for dropping either end of the ribbon while on course, breaking the ribbon while on course, or holding or locking hands while on course.

Note: A fresh ribbon must be given to each team. All ribbons shall be of the same width. Time begins when the first part of either horse crosses the timing line and ends when the last part of the last horse crosses the timing line.

POLES II RELAY

(2 or 5 person)

Course Layout:

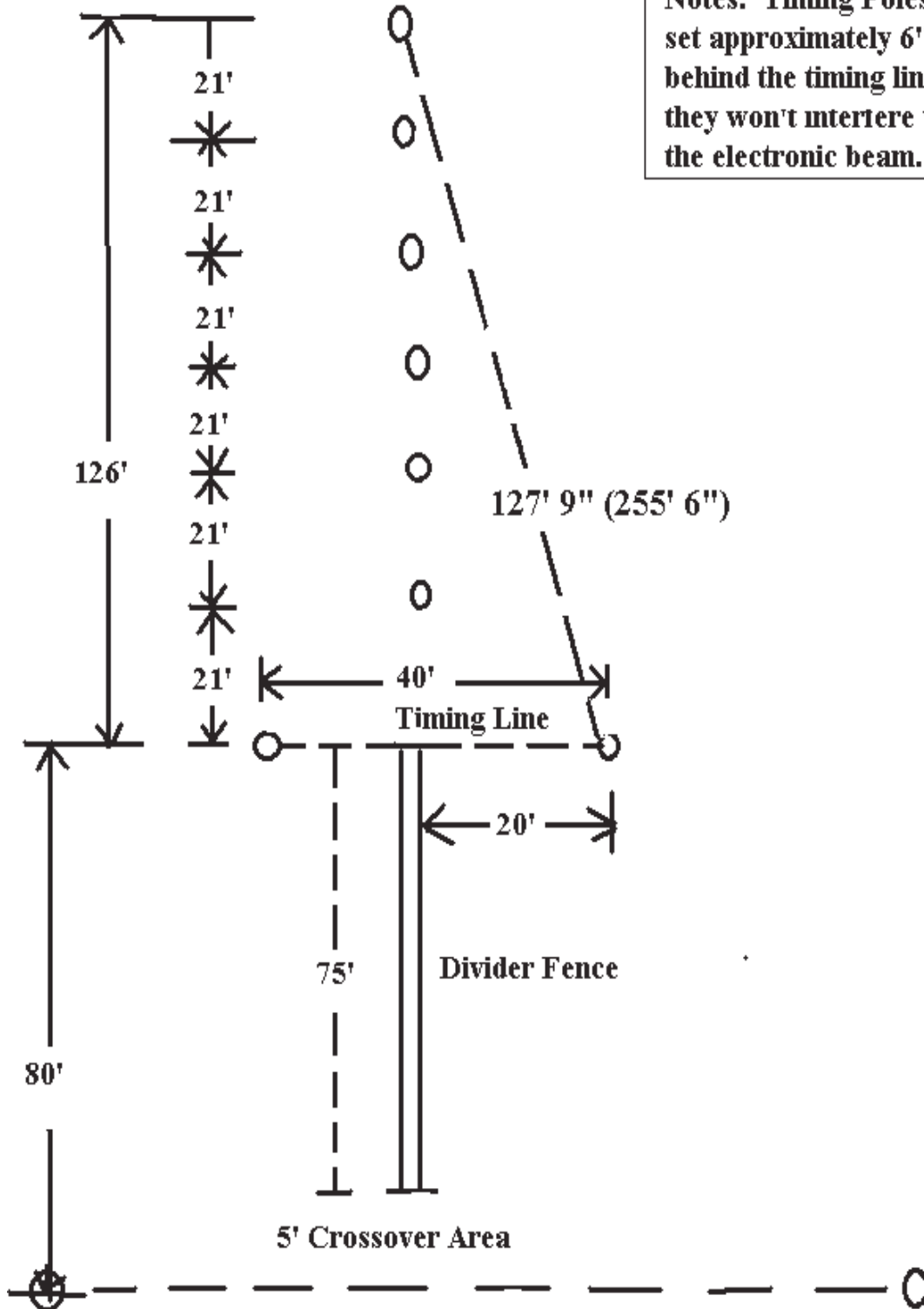

Obstacles:

8 Poles

Safety Fence

Notes: Timing Poles are set approximately 6" behind the timing line so they won't interfere with the electronic beam.

Poles II Relay Course pattern: To be run in accordance with rules set up for Pole Bending II, except that the riders must stay on opposite side of divider fence from where they started.

Special penalties: More than one horse on course at the same time shall result in a disqualification.

Notes:

1. A safety fence shall be placed between the riders who have finished the course and those who have not started it.
2. All riders on a team must start the course from the same side.

SPEED BALL RELAY

(2 or 5 person)

Course Layout:

See Appendix A
for cone
construction

Obstacles:

2 Poles, 1 Cone,
5 Golf Balls, Divider

Notes: Timing Poles are
set approximately 6"
behind the timing line so
they won't interfere with
the electronic beam.

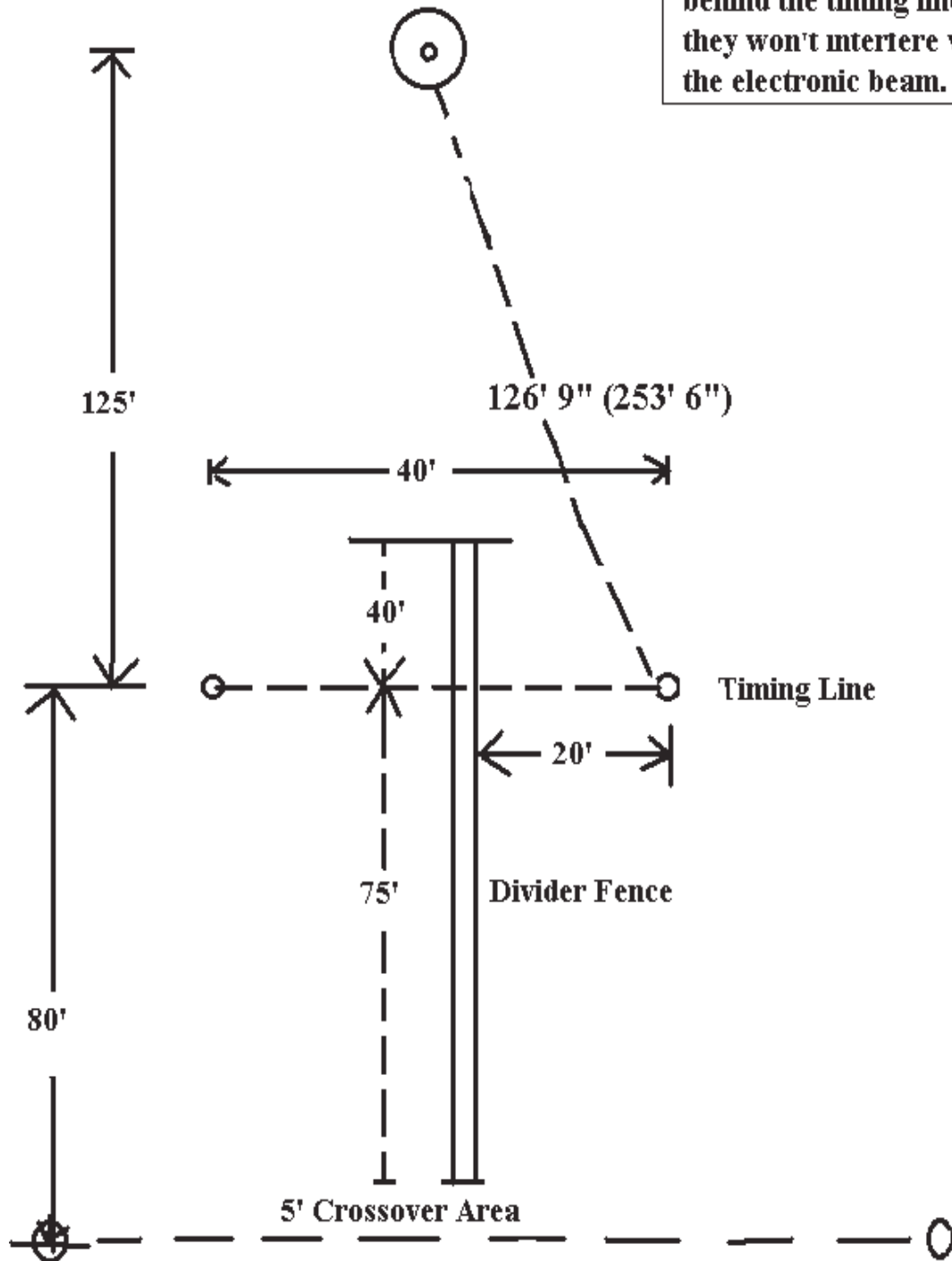

Speed Ball Relay Course pattern: To be run the same as the rules for Speed Ball, except that there are 2 or 5 persons on a team. All riders must start on one side of the divider fence and finish on the opposite side of the divider fence. The riders must stay on opposite side of divider fence from where they started. The winner is the team with the most golf balls in the cone with the fastest time.

Note: A team shall be disqualified for the following:

1. More than one rider on course.
2. If any member of the team knocks over the cone.

Section 9: Protests

- a. Written protests, accompanied with a fee of \$25 cash must be submitted to the horse show secretary within 30 minutes after completion of the protested event.
- b. Approved protests will result in a refund of the \$25 fee. Fees from unapproved protests will be directed to the CGA general fund.
- c. A copy of the written protest shall be forwarded to the CGA Gymkhana Rules Committee. All protests will be reviewed by this committee with the intention of eliminating ambiguities that might exist in the rule book.
- d. Under NO circumstances can a judge's ruling be overruled by show management.

Appendix A: Construction of Cone for Speed Ball

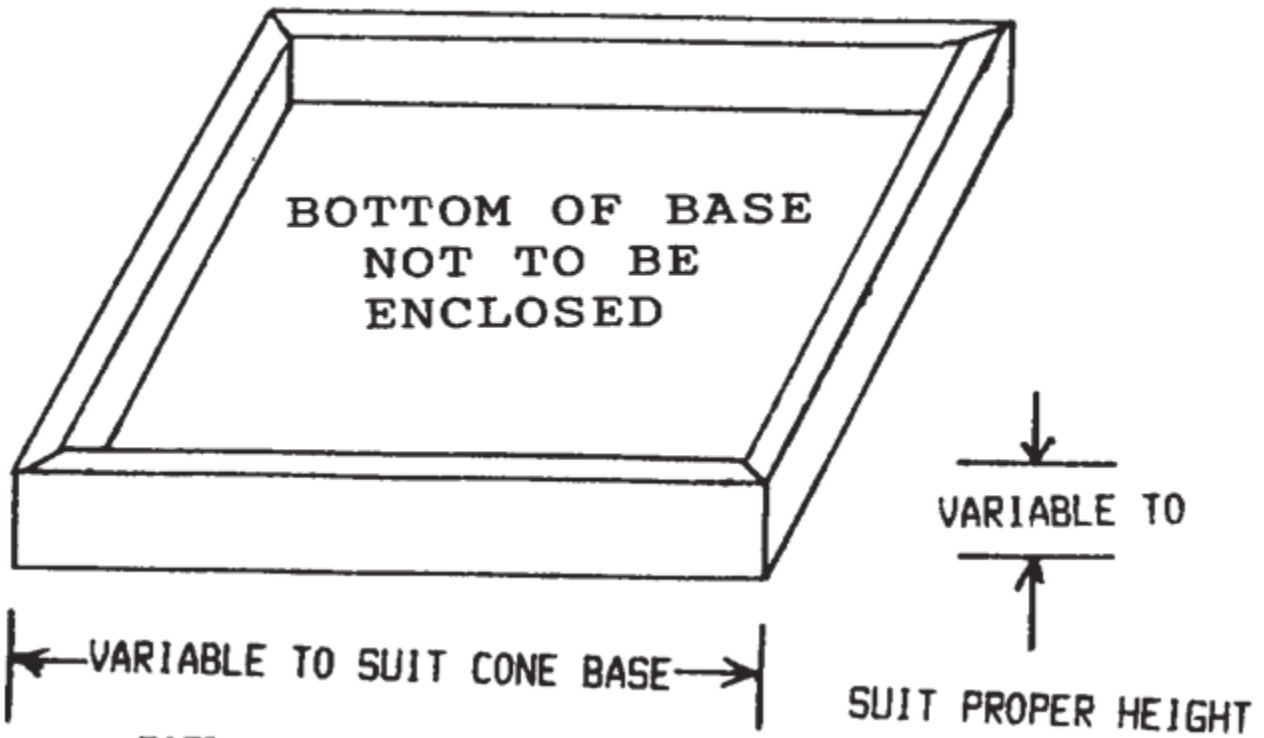
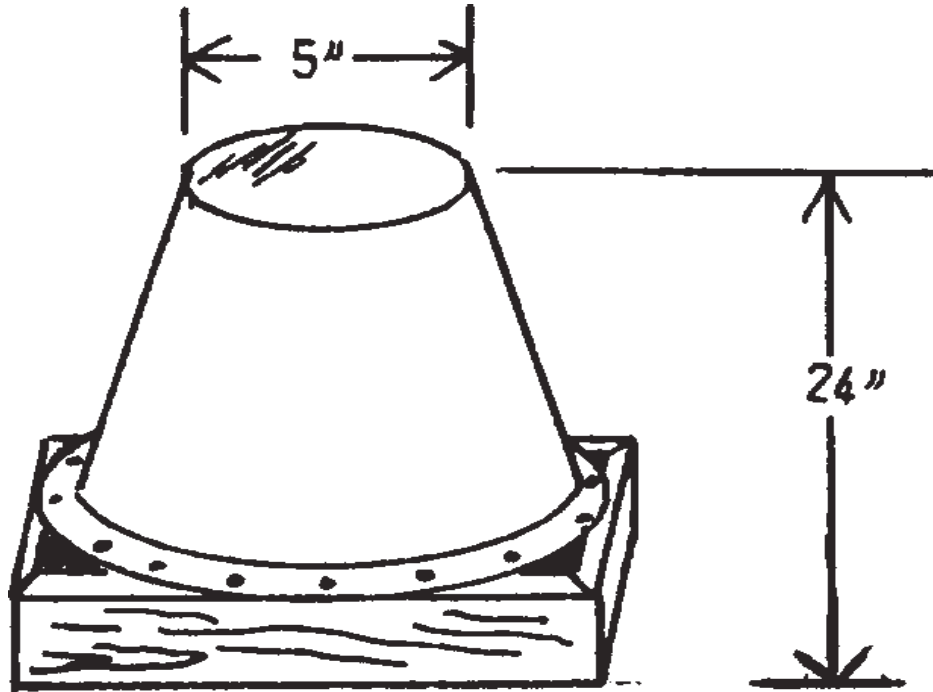

Appendix B: Construction of Poles for Pole Bending

Note: "Blackwood" is a brand name. The base must be solid rubber. The top 6" must be painted a contrasting color.

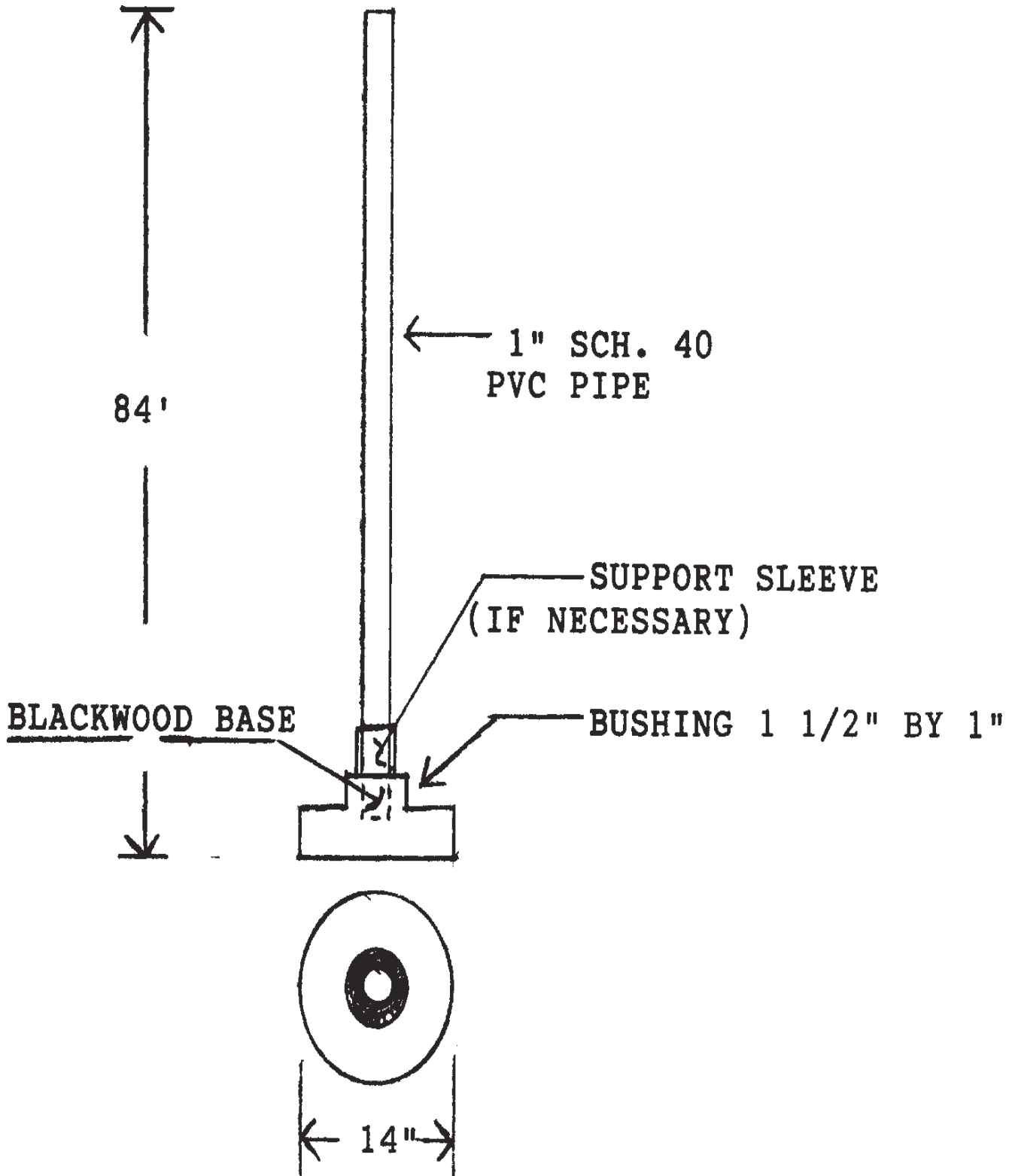

Appendix C: Construction of Hurry Scurry Jumps

1 ½ “ schedule 40 white pvc pipe: each length 5 feet long; each length covered with standard plumber’s foam insulation and the insulation then covered with white duct tape. The center support shall be made of extruded polyethylene 4 to 4 ½ “ thick, 16” wide and 16” high. This is accomplished by gluing two pieces of foam together. A notch is cut that is 3 ½” deep x 4” wide in the center of the foam to support the pvc poles. The outer end of the poles will be supported by standard white plastic “Bloks”.

Appendix D: Pony Measurements

Stand pony on a smooth, level surface in such a position that the front legs and back legs are vertical. The head of the pony should be in a natural position, similar to the picture below. The pony's poll shall not be below the withers. With the pony in this position, measure the vertical distance from the highest point of the withers to the ground. The arm of the measuring standard shall be placed over the highest point of the withers and no measurement taken at any other part of the pony's body shall count. The standard must be straight, stiff and should be provided with a plum bob or spirit level to make sure the standard is perpendicular from the withers to the ground and that the cross piece is parallel with the ground surface.

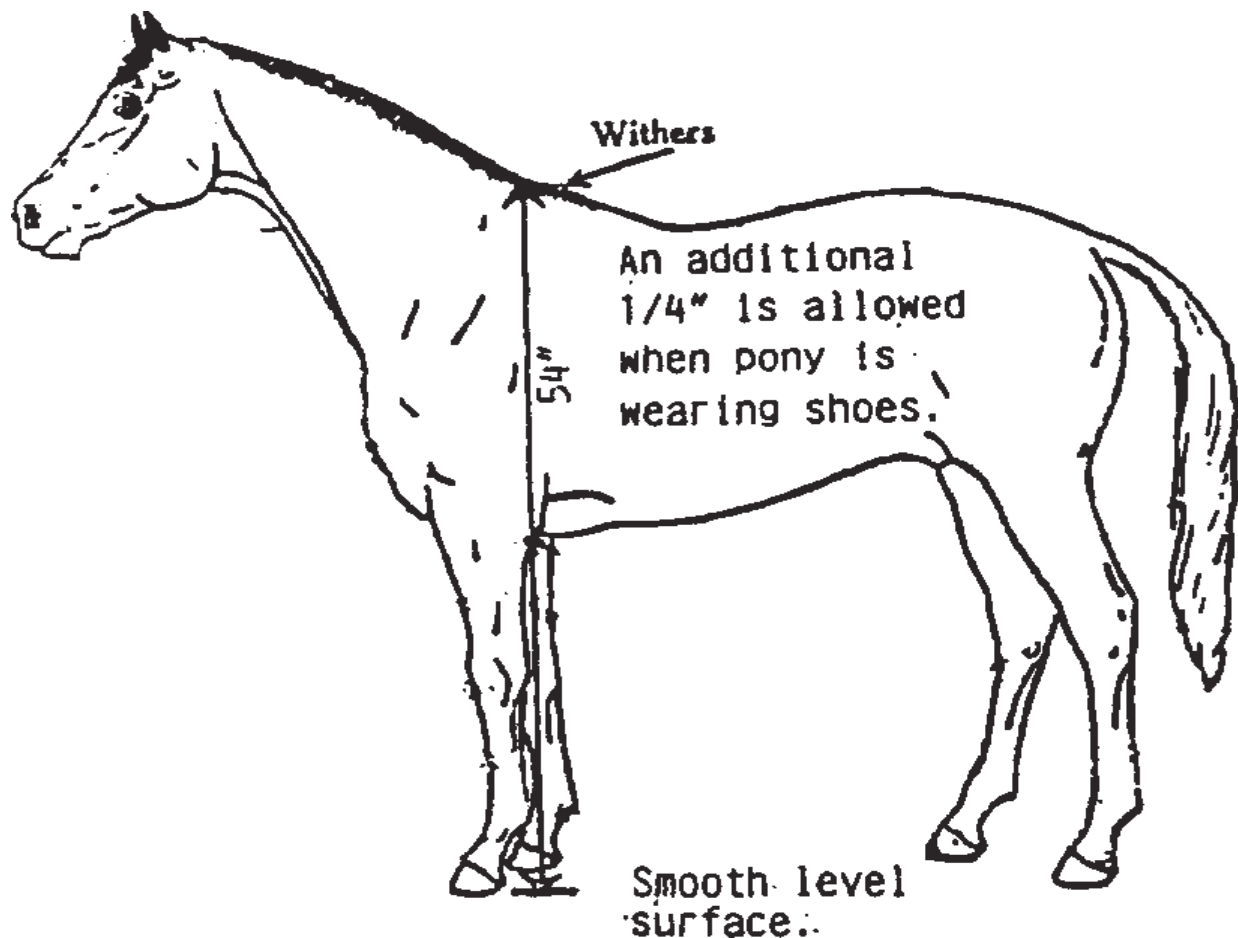

Bolado Park State Show Records

Horses

<i>Event</i>	<i>Rider</i>	<i>Date</i>	<i>Time</i>
BAR	Margo Abatti/Doc	1993	17.740
BR	Lea DeMontigny/Galbraiths No Doc	1996	13.032
F8F	Margo Abatti/Doc	1993	10.652
F8S	Makayla Foster/Aftershock	2006	10.333
HS	Sierra Shaw/Cowboy Boogies	2005	9.117
KH	Sierrah Madrigsl/Bubba	2014	6.922
P1	Mitch Honig/Mr Mac	1982	9.060
P2	Mariah deMontigny/Bar de Pavo	2007	19.981
QR	Makayla Foster/Aftershock	2003	18.216
SBL	Jennifer Brown/Front Page Gem	2003	6.984
SBR	Monique Fimbres/Pass-N-Fuel	2003	9.232
SSR	Margo Abatti/Doc	1993	8.839
BT	Makayla Foster/Aftershock	2002	13.753

Ponies

<i>Event</i>	<i>Rider</i>	<i>Date</i>	<i>Time</i>
BAR	Cindy Duncan/Flicka	1983	18.080
BR	Stephanie Langdon/Dapper Dew Right	2007	13.482
F8F	Kristel Vaughn/Dusty Sue	1991	10.780
F8S	Avielle Lehman/Suncrest Hello Dolly	2013	10.652
HS	Avielle Lehman/Suncrest Hello Dolly	2012	9.438
KH	Lea deMontigny/Tyme to Aplaud	2016	6.866
P1	Stephanie Langdon/Missy	1996	9.110
P2	Stephanie Langdon/Dapper Dew Right	1999	20.620
QR	Stephanie Langdon/Dapper Dew Right	2007	18.727
SBL	Avielle Lehman/Suncrest Hello Dolly	2013	7.138
SBR	Lea deMontigny/Tyme to Aplaud	2016	9.632
SSR	Avielle Lehman/Suncrest Hello Dolly	2013	9.300
BT	Roquel Merrick/Fanci	2010	13.921

Bolado Park State Show Records: Team Events

1981 Rescue Race	9.580	Richard Haley/Joker Ben Valdez
1990 Ribbon Race	9.330	Denise Knight/Dunny Lisa Weniger/Bob Lee Reed
1994 2-Person Poles II	43.407	Megan Freeman/Shy Girl David Stokes/Revelation
1992 2-Person Speed Ball	17.009	Lea deMontigny/Galbraiths No Doc Michele Curry/Pepa Lynx Anne
2011 5-Person Speed Ball	49.643	Kasey Stevens/Decco MegaPep Jeannette Steward/Turbo Jennifer Braswell/Gus Morgan Cook/Nitro Anna Rose/Lil Brat

All Time State Show Records

Horse

<i>Event</i>	<i>Rider</i>	<i>Date</i>	<i>Time</i>
BAR	Joyce Jackson/Trent Tivio	1984	17.200
BR	Jeff Taggart/Pee Wee	1984	12.910
F8F	Jeff Taggart/Renee	1984	10.620
F8S	Toni Johnson/Casino	1984	10.270
HS	Sierra Shaw/Cowboy Boogie	2005	9.117
KH	Missy DePasse/Butter Scott	1987	6.780
P1	Mitch Honig/Mr Mac	1982	9.060
P2	Mariah deMontigny/Bar de Pavo	2007	19.981
QR	Makayla Foster/Aftershock	2003	18.216
SBL	GiGi Ward/Pee Wee	1978	6.820
SBR	Missy DePasse/Butter Scott	1987	9.080
SSR	GiGi Ward/Pee Wee	1979	8.740
BT	Makayla Foster/Aftershock	2002	13.753

Ponies

<i>Event</i>	<i>Rider</i>	<i>Date</i>	<i>Time</i>
BAR	Cindy Duncan/Flicka	1983	18.080
BR	Stephanie Langdon/Dapper Dew Right	2007	13.482
F8F	Kristel Vaughn/Dusty Sue	1991	10.780
F8S	Avielle Lehman/Suncrest Hello Dolly	2013	10.652
HS	Avielle Lehman/Suncrest Hello Dolly	2012	9.438
KH	Stephanie Langdon/Dapper Dew Right	2002	6.933
P1	Tracy Riley/Benji	1980	8.930
P2	Jenell Decker/Rainbow	1987	20.130
QR	Stephanie Langdon/Dapper Dew Right	2007	18.727
SBL	Avielle Lehman/Suncrest Hello Dolly	2013	7.138
SBR	Avielle Lehman/Suncrest Hello Dolly	2013	9.652
SSR	Avielle Lehman/Suncrest Hello Dolly	2008	9.300
BT	Roquel Merrick/Fanci	2010	13.921

All Time State Show Records: Team Events

1981 Rescue Race	9.580	Richard Haley/Joker Ben Valdez
1990 Ribbon Race	9.330	Denise Knight/Dunny Lisa Weniger/Bob Lee Reed
1994 2-Person Poles II	43.407	Megan Freeman/Shy Girl David Stokes/Revelation
1984 5-Person Poles II*	153.565	Jennifer Bowler/Black Baby Jenell Decker/Rainbow Julie Robson/Cindy Gail Robson/Shotgun Kathy Burrigh/Starfire Britches
1992 2-Person Speed Ball	17.009	Lea deMontigny/Galbraiths No Doc Michele Curry/Pepa Lynx Anne
2011 5-Person Speed Ball	49.643	Kasey Stevens/Decco MegaPep Jeannette Steward/Turbo Jennifer Braswell/Gus Morgan Cook/Nitro Anna Rose/Lil Brat

* **5-Person Poles II** – Event is no longer run.

